

XAL 24

EN

DE

News

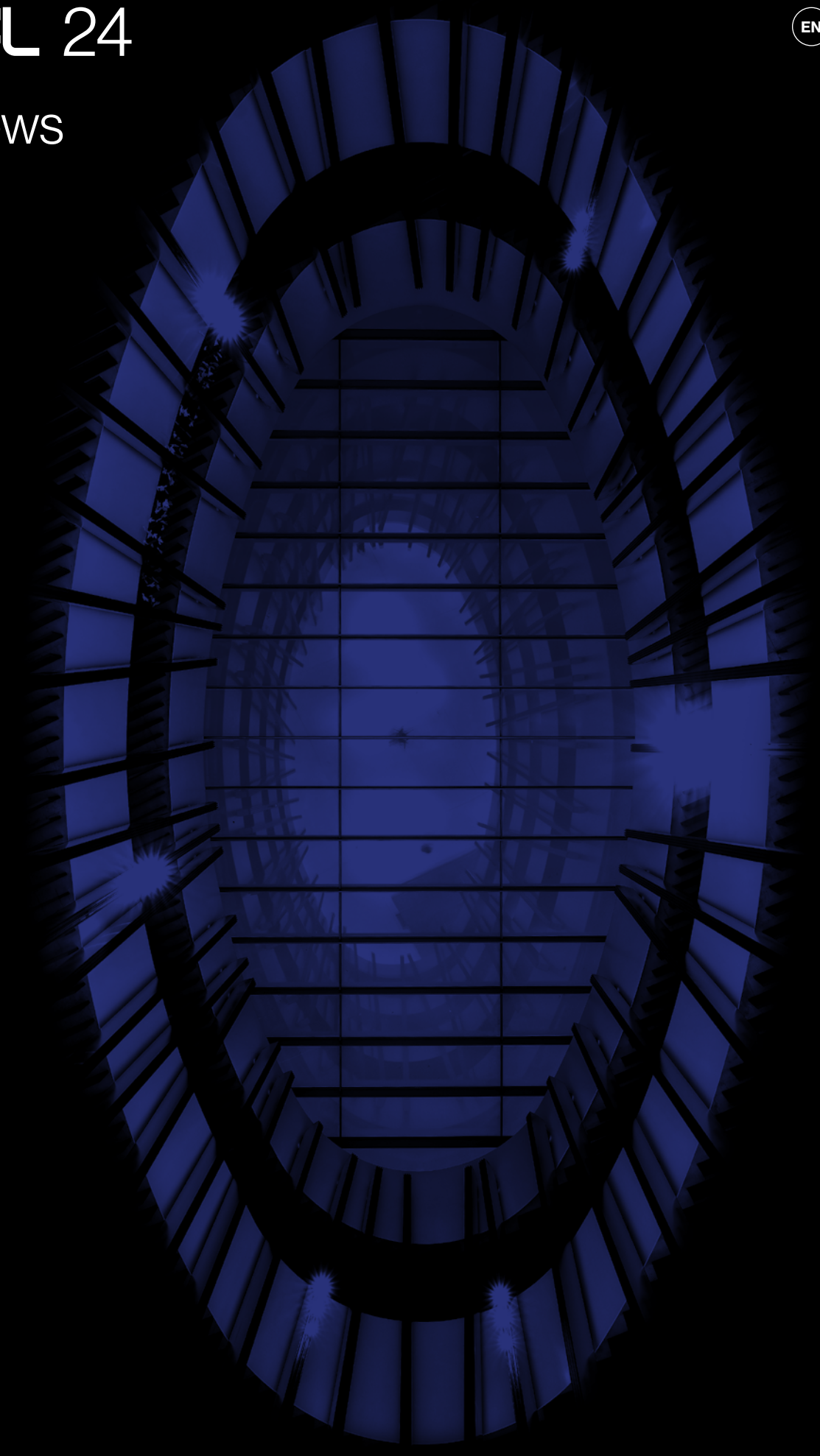











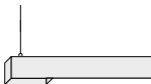
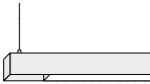

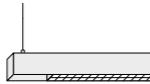

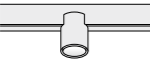
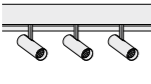
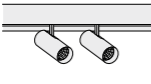
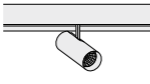
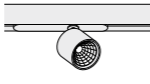
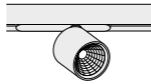
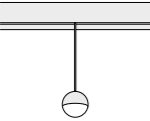
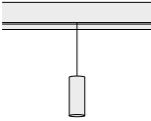

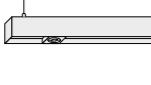
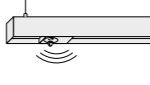
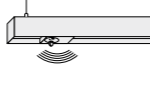
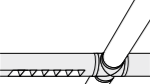

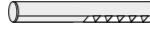

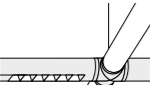





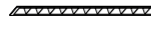
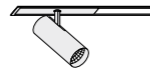





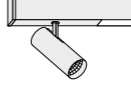
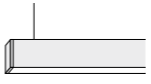

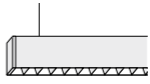
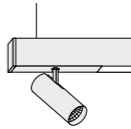
Lighting without limits

EN It all begins with a passion for light. For 35 years, XAL has been working with lighting designers and architects to develop custom luminaires of the highest technical standard, which impress with their style and aesthetics. There is always one goal: to push the boundaries of the technically feasible, enabling visionary designs. We can meet this challenge because our employees in our design labs as well as in our production and sales locations around the world deliver top performance. Being on-site for our customers is essential for mutual success. Thanks to organisational efficiency and high in-house production depth, we can tailor our response to the needs of our customers and continuously expand our existing product portfolio. Meeting seemingly impossible challenges is our daily motivation and inspiration. From novel concept to luminaire innovation: a path created by crossing borders. **Lighting without limits.**

DE Alles beginnt mit der Leidenschaft für Licht. Seit 35 Jahren entwickelt XAL gemeinsam mit LichtdesignerInnen und ArchitektInnen individuelle Leuchten auf dem höchsten Stand der Technik, die zudem durch Stil und Ästhetik überzeugen. Immer mit einem Ziel: die Grenzen des technisch Machbaren zu überschreiten und dadurch visionäre Entwürfe zu ermöglichen. Das gelingt, da unsere MitarbeiterInnen in unseren Design-Labs sowie Produktions- und Vertriebsstandorten auf der ganzen Welt Höchstleistungen erbringen. Vor Ort für unsere KundInnen da zu sein, ist grundlegend für gemeinsame Erfolge. Dank organisatorischer Effizienz und einer hohen inhouse Fertigungstiefe können wir individuell auf die Bedürfnisse unserer KundInnen eingehen und unser bestehendes Produktportfolio laufend erweitern. Scheinbar unmöglichen Anforderungen zu begegnen, ist für uns täglich Antrieb und Inspiration. Vom neuartigen Konzept zur Leuchteninnovation: ein Weg, der durch Grenzüberschreitung entsteht. **Lighting without limits.**

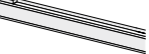
Products

MOVE IT PRO system channels							
	recessed 36	surface 36	suspended 36				
	32						
linear insets							
	OPAL 40	LOUVER 42	SHELF FLOOR WASHER 44	SPOT LINE 46	LENS 48	INDIRECT 50	
spotlight insets							
	TARO 52	BO 32 54	BO 45 54	BO 55 54	VARO 80 S 56	VARO 110 S 56	
decorative insets							
	NOBA 58	ARY 60					
emergency insets			sensor insets				
	EMERGENCY SIGN 62	SAFETY LUMINAIRE 62				ESSENTIAL 39	SENSE 39
CONEX system ceiling							
	CONEX connector 67	TUBO 60 70	TUBIN 60 72	SETA 60 74	SETA 60 track 74		
64							
suspended							
	CONEX connector 67	TUBO 60 70	TUBIN 60 72	SETA 60 74	SETA 60 track 74		
FRAME 40 system recessed trim							
	opal 82	microprismatic 82	reflector 84	spotlight 90			
76							

MINO 40 system ceiling				
	opal 86	microprismatic 86	reflector 88	spotlight 90
76				
suspended				
	opal 86	microprismatic 86	reflector 88	spotlight 90
MILA system ceiling				
	opal 96	microprismatic 96	reflector 98	sensor 95
92				
VITA wall				
	single 106	system 108		
100				
Smart products				
	UNICO Q1 sensor 112	SASSO 60 sensor 112	MILA system sensor 112	
110				

Projects

Maria Ward School Nuremberg, DE Architecture by H2M Architekten Lighting design by Konzeptlicht, Gregor Sgonina	6
Digital Campus Berlin, DE Architecture by SCOPE Architekten GmbH	14
MAM Competence Center Großhöflein, AT Architecture by INNOCAD Architektur ZT Lighting design by INNOCAD Architektur ZT	20
Health Resort Lanserhof Sylt, DE Architecture by Christoph Ingenhoven with ingenhoven associates Lighting design by Tropp Lighting Design	26

A bright future

EN The newly built Maria Ward School in Nuremberg is a school that knows no dark corners. It draws its character from the bright, daylight-flooded atrium, places for retreat and exchange, and the continuous wayfinding system. This creates an inspiring environment that motivates students to develop their full potential.

The lighting supports the perception of the building structure. The directional lines of light are recognisable from the outside and lead into the building. To create a smooth transition between classrooms, movement zones, and learning areas, and to promote concentration and well-being, the linear luminaires' illuminance in these adjacent areas is always between 300 and 500 lux. The energy footprint of the CO₂-neutral school building is optimised thanks to brightness and movement sensors. The lighting concept achieves a harmonious combination of comfort and functionality for improved well-being and focus. A school without dark corners, but with plenty of space for development.

Maria Ward School Nuremberg

DE Die Nürnberger Maria-Ward-Schule ist eine Schule, die keine dunklen Ecken kennt. Sie bezieht ihren Charakter durch das helle, tageslichtdurchflutete Atrium, das durchgängige Leitsystem, Farben, Glaselemente, Orte für Rückzug und Austausch, viel Raum für Bewegung und liebevoll angelegte Grünflächen. So entsteht eine inspirierende Umgebung, die Schülerinnen dazu motiviert, ihr volles Potenzial zu entfalten.

Die vom Außenbereich ins Innere der Schule führenden diffusen Lichtlinien unterstützen bei der Wahrnehmung der Gebäudestruktur. Um den Übergang zwischen Klassenzimmern, Bewegungszonen und Lernbereichen fließend zu gestalten und Konzentration und Wohlbefinden zu fördern, liegt die Beleuchtungsstärke in diesen angrenzenden Bereichen immer zwischen 300 und 500 lux. Die Energiebilanz des CO₂-neutralen Schulgebäudes wird durch den Einsatz von Bewegungs- und Helligkeitssensoren optimiert. Mit diesem Lichtkonzept gelingt eine harmonische Verbindung von Komfort und Funktionalität. Eine Schule ohne dunkle Ecken, dafür viel Raum zur Entfaltung.

Maria Ward School
Nuremberg, DE

Architecture by
H2M Architekten

Lighting Design by
Konzeptlicht, Gregor Sgonina

SASSO
MINO
MINO CIRCLE
MINIMAL



Maria Ward School Nuremberg, DE –
by H2M Architekten with lighting design
by Konzeptlicht, Gregor Sgonina







“The use of daylight and presence sensors has each yielded savings of 25 percent. Combined, this results in an energy saving of 45 percent, achieved purely through the lighting management system. This has greatly impressed us lighting designers.”

Gregor Sgonina, lighting designer, Konzeptlicht lighting solutions GmbH



Campus culture 4.0

EN A forward-looking place that promotes communication, collaboration, and creativity, that embodies the idea of a modern working environment – this is what SCOPE Architects have created with the Digital Campus for Europe's largest software company. The lighting challenge was to find a product that would meet the varied requirements for meeting rooms, foyers, event areas, work cafés, break zones, corridors, and plant lighting. The flexible MOVE IT track system facilitates the integration of various technical and decorative luminaires. The system is ideal for the diverse uses of the building, and offers the right inset for every area. This feature not only proved useful during the construction phase, but the tool-free and magnetic installation facilitates were straightforward to use and extend, especially during operation. With the PIVOT luminaire, the architects have taken up the look of the track rails in the corridors – as an analogy to the track bed of the nearby main railway station.

For the approximately 1,300 workstations, the architects wanted to use a circular luminaire to echo the aesthetic appearance of the PIVOT luminaires for the general lighting. Developed by XAL in creative collaboration with SCOPE Architects, the efficient SETA office luminaire was created – tailored to the special requirements of computer workstations. With its round, elegant shape, it supports well-being at the workplace and provides perfect work light with a colour rendering value of up to CRI ≥ 98.

DE Ein zukunftsweisender Ort, der Kommunikation, Kollaboration und Kreativität fördert, der die Idee einer modernen Arbeitswelt verkörpert – den haben SCOPE Architekten mit dem Digital-Campus für Europas größtes Softwareunternehmen geschaffen. Die Herausforderung für die Beleuchtung lag darin, ein Produkt zu finden, das den vielfältigen Anforderungen an Meetingräume, Foyers, Veranstaltungsbereiche, Workcafés, Pausenzonen, Flure und die Pflanzbeleuchtung gerecht wird. Das flexible Schienensystem MOVE IT ermöglicht die Integration verschiedener technischer und dekorativer Leuchten. Aufgrund der Nutzungsvielfalt des Gebäudes ist das System optimal einsetzbar und bietet für jeden Bereich das passende Licht-Inset. Diese Eigenschaft erwies sich nicht nur während der Bauphase als nützlich, sondern insbesondere im laufenden Betrieb ermöglicht die werkzeuglose und magnetische Montage eine unkomplizierte Bedienung und Erweiterung. Mit der Leuchte PIVOT haben die Architekten die Optik der Gleisschienen in den Fluren aufgenommen – als Analogie zum Gleisbett des unmittelbar in der Nähe liegenden Hauptbahnhofs.

Für die rund 1.300 Arbeitsplätze war es der Wunsch der ArchitektInnen eine runde Leuchte einzusetzen, um das ästhetische Erscheinungsbild der PIVOT Leuchten für die Allgemeinbeleuchtung aufzugreifen. Entwickelt von XAL und in gestalterischer Zusammenarbeit mit SCOPE Architekten entsteht die effiziente Office Leuchte SETA – zugeschnitten auf die speziellen Anforderungen von Bildschirmarbeitsplätzen. Durch ihre runde, elegante Form unterstützt sie das Wohlbefinden am Arbeitsplatz und sorgt für perfektes Arbeitslicht mit einem Farbwiedergabewert von bis zu CRI ≥ 98.

Digital Campus Berlin, DE

Architecture by
SCOPE Architekten GmbH

MOVE IT 25 S system
MOVE IT 45 system
SETA
SASSO



“Adapted to the needs of the employees and the requirements of the hybrid world of work, we have created an office space that is designed for flexibility and further development.”

Yvonne Hackh, SCOPE Architekten GmbH



Digital Campus Berlin, DE –
by SCOPE Architekten GmbH



Growing organism

EN As a company, MAM is like a growing organism. This means, the new research and development centre will also have the ability to grow over the years and offer a sustainable and expandable working environment for up to 180 employees. The INNOCAD concept responds to this complex task of organic growth using the principle of cell division. Three circular, interlocking structures are connected to one another like abstract cells and gently blend into the hilly landscape.

The lighting design for the work area was a central concern of the architects. Linear workplace lights underline the radial design language of the acoustic ceiling. The communication areas are selectively illuminated by recessed SASSO downlights. An acoustic-light combination was used in the meeting areas to create optimum conditions for communication and concentrated work.

DE MAM als Unternehmen gleicht einem wachsenden Organismus. Demzufolge soll das neue Forschungs- und Entwicklungszentrum ebenfalls über die Jahre mitwachsen können und ein zukunfts- und ausbaufähiges Arbeitsumfeld für bis zu 180 MitarbeiterInnen bieten. Dieser komplexen Aufgabenstellung des organischen Wachstums antwortet das Konzept von INNOCAD mit dem Prinzip der Zellteilung. Drei kreisförmige aneinandergereihte Baukörper sind wie abstrahierte Zellen miteinander verbunden und fügen sich behutsam in die hügelige Landschaft ein.

Die Lichtplanung für den Arbeitsbereich war ein zentrales Anliegen der ArchitektInnen. Lineare Arbeitsplatzleuchten unterstreichen die radiale Formensprache der Akustikdecke. Die Kommunikationsflächen werden von zurückgesetzten SASSO Downlights punktuell erhellt. In den Besprechungsbereichen wurde eine Akustik-Licht-Kombination eingesetzt, um optimale Bedingungen für die Kommunikation und konzentriertes Arbeiten zu schaffen.





“The result is an organic, growing building in which the respective parts of the building flow seamlessly into one another. Each part works on its own, but benefits from the others.”

Martin Lesjak, CEO, Design Director and Co-Founder, INNOCAD Architektur ZT





MAM Competence Center
Großhöflein, AT –
by INNOCAD Architektur ZT
including lighting design



In harmony with nature

EN Christoph Ingenhoven with ingenhoven associates realised the latest Lanserhof – a medical health resort – in the north of the island of Sylt. In close cooperation with the conservation authorities, a former officers' home from the 1930s was converted into the centrepiece of the entire Lanserhof ensemble. This existing building, with its thatched roof as a design element, serves as a model for the other new buildings. At 7,100 square metres, Lanserhof Sylt has the largest thatched roof in Europe.

The careful integration of the architecture into the surrounding protected dune landscape is a central concern of this project. Natural materials, harmonious and simple rooms are the building blocks of health-promoting architecture. The lighting is planned in a targeted and restrained manner. The experience of the special architecture and the surrounding natural landscape creates the atmosphere of peace, relaxation and healing that guests are looking for in this place. The natural and dynamic daylight in the building is the indirect element that connects the interior with the natural dune and coastal landscape. Beyond this, artificial light is only used to emphasise certain areas, create atmosphere and ensure functionality. To this end, the architects chose a warm light colour of 3000K and very good colour rendering of CRI \geq 97.

Health Resort Lanserhof Sylt

Health Resort Lanserhof
Sylt, DE

Architecture by
Christoph Ingenhoven
with ingenhoven associates

Lighting Design by
Tropp Lighting Design

SASSO

DE Christoph Ingenhoven realisierte mit ingenhoven associates im Norden der Insel Sylt den neuesten Lanserhof – ein Medical Health Resort. In enger Zusammenarbeit mit dem Denkmal- und Naturschutz wurde ein ehemaliges Offiziersheim aus den 1930er Jahren als Mittelpunkt des gesamten Lanserhof Ensembles umgebaut. Dieses Bestandsgebäude mit reetgedecktem Dach als gestalterisches Element dient als Vorbild für die weiteren Neubauten. Zusammen verfügt der Lanserhof Sylt mit 7.100 Quadratmetern über das größte reetgedeckte Dach Europas.

Die achtsame Einbindung der Architektur in die umgebende geschützte Dünenlandschaft ist ein zentrales Anliegen dieses Projekts. Naturbelassene Materialien, harmonische und schlichte Räume sind die Bausteine einer gesundheitsfördernden Architektur. Die Beleuchtung ist gezielt und zurückhaltend geplant. Das Erleben der besonderen Architektur und der umgebenen Naturlandschaft schafft die Atmosphäre der Ruhe, Entspannung und Heilung, die die Gäste an diesem Ort suchen. Das natürliche und dynamische Tageslicht im Gebäude ist das mittelbare Element, das den Innenraum mit der natürlichen Dünen- und Küstenlandschaft verbindet. Darüber hinaus wird künstliches Licht nur eingesetzt, um bestimmte Bereiche zu betonen, Atmosphäre zu schaffen und Funktionalität zu gewährleisten. Dazu haben die Architekten eine warme Lichtfarbe mit 3000K und sehr guter Farbwiedergabe von CRI \geq 97 gewählt.



Health Resort Lanserhof Sylt, DE –
by Christoph Ingenhoven with ingen-
hoven associates and lighting design
by Tropp Lighting Design

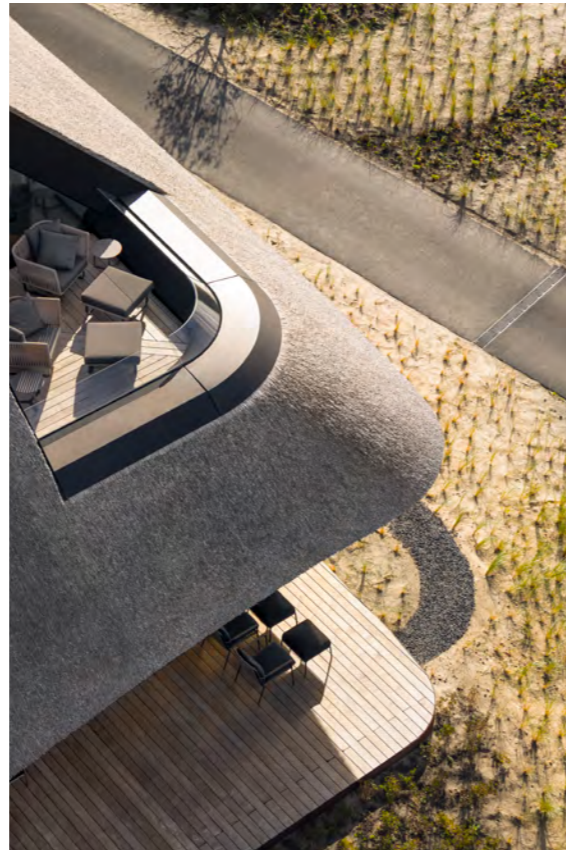



Health Resort Lanserhof Sylt, DE –
by Christoph Ingenhoven with ingen-
hoven associates and lighting design
by Tropp Lighting Design





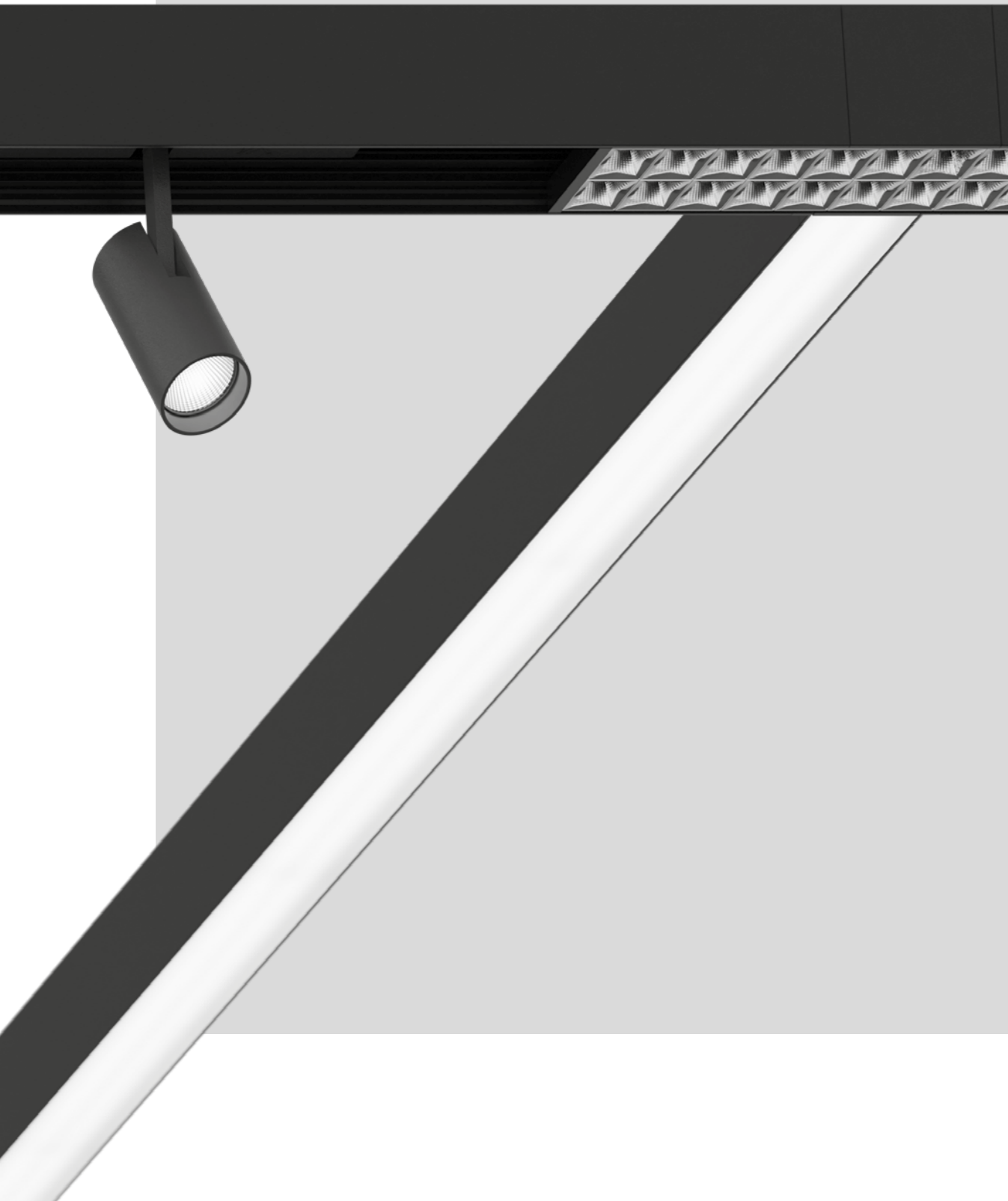







One system All spaces No limits



MOVE IT PRO

EN Experience limitless design freedom with the versatile MOVE IT PRO high-voltage track system. This 3-phase DALI track offers two separate emergency lighting circuits. A range of sensors and flexible indirect light insets facilitate a holistic solution. The tool-free installation and wide range of linear optics and spotlights allow creative design freedom in offices, restaurants, shops, educational institutions, and public spaces. As a recessed, surface-mounted or suspended system with L-, T-, and X-connectors, it facilitates customised arrangements.

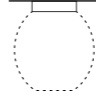
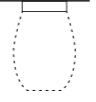
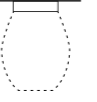
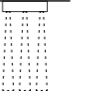
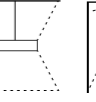
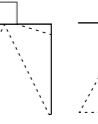
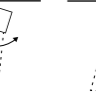
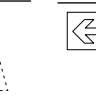
DE Erleben Sie grenzenlosen Gestaltungsfreiraum mit dem vielseitigen Hochvolt-Stromschienensystem MOVE IT PRO. Diese 3-Phasen-DALI-Stromschiene bietet zwei separate Notlichtkreise. Verschiedene Sensoren und flexible Indirektlichteinsätze ermöglichen eine ganzheitliche Lösung. Die werkzeuglose Montage und Vielzahl an linearen Optiken und Strahlern erlauben Freiheit in der Planung von Büros, Restaurants, Shops, Bildungseinrichtungen und öffentlichen Räumen. Als eingebautes, angebautes oder abgehängtes System mit L-, T- und X-Connectors ermöglicht es individuelle Arrangements.

Type	
	45 x 59
Mountings	  
	recessed surface suspended
Configurations	   
	linear L-connector T-connector X-connector
Light distributions	        
	opal louver (UGR ≤ 19) lens (UGR ≤ 19) spot line (UGR ≤ 19) direct indirect shelf floor washer spotlight decorative emergency

A wide range of applications

Office

EN The glare-free LENS, LOUVER, and SPOT LINE office insets are perfect for computer workstations. The wide indirect light distribution creates a pleasant work atmosphere, while OPAL, BO and TARO insets provide ideal general lighting as well as optimised lighting in common areas and passageways.

DE Die blendfreien Office-Insets LENS, LOUVER und SPOT LINE sind perfekt für Bildschirmarbeitsplätze. Das breit abstrahlende Indirektlicht verleiht eine angenehme Arbeitsatmosphäre, während OPAL, BO und TARO Insets die Allgemeinbeleuchtung sowie Aufenthalts- und Durchgangsbereiche ideal beleuchten.



Hospitality

EN The right insets for a pleasant atmosphere in restaurants and hotels are versatile. The indirect lighting insets create a pleasant atmosphere: OPAL and SPOT LINE for use as general lighting, BO and TARO for skilful accent lighting, and NOBA and ARY are the best choice for decorative highlights.

DE Die passenden Insets für eine angenehme Stimmung in Restaurants und Hotels sind vielfältig. Die Indirektlicht-Insets sorgen für eine angenehme Atmosphäre, OPAL und SPOT LINE für den Einsatz als Allgemeinbeleuchtung, BO und TARO für gekonnte Akzentuierung und NOBA und ARY sind für dekorative Highlights die beste Wahl.

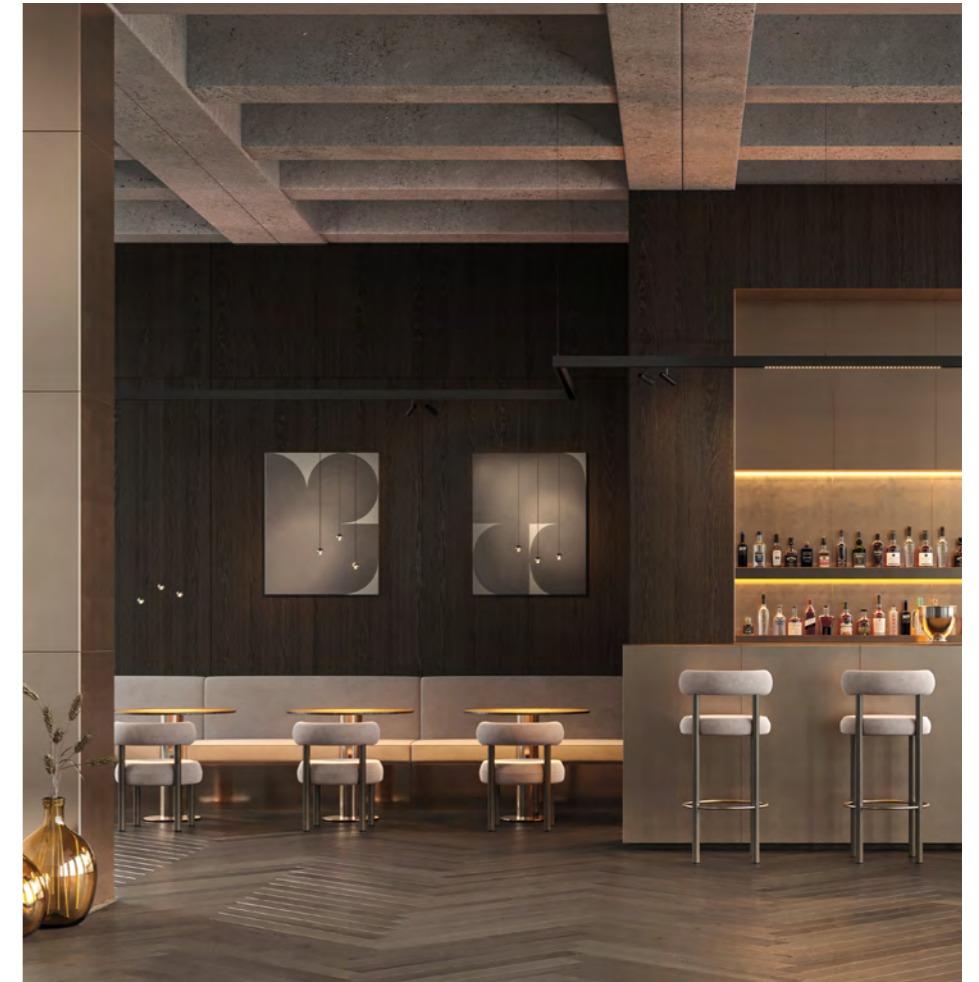

Retail

EN The uniform illumination provided by the SHELF FLOOR WASHER insets skilfully stages shelves in supermarkets, boutiques, and fashion stores. Targeted highlights can be created with the one-, two-, or three-lamp BO shop spotlights. Other insets compatible with MOVE IT PRO, such as the VARO and SQUADRO shop spotlights, complete the selection.

DE Die gleichmäßige Ausleuchtung durch die SHELF FLOOR WASHER Insets setzt Regale in Supermärkten, Boutiquen und Fashion Stores gekonnt in Szene. Mit dem ein-, zwei- oder dreiflämmigen Shop Strahler BO können gezielt Highlights gesetzt werden. Weitere mit MOVE IT PRO kompatible Insets wie die Shopstrahler VARO und SQUADRO – komplementieren die Auswahl.



Education

EN Lighting creates an ideal learning environment in buildings and contributes significantly to orientation. LOUVER insets are the first choice for classrooms in schools and universities, while OPAL insets provide uniform illumination in corridors.

DE Beleuchtung schafft eine ideale Lernumgebung in Gebäuden und trägt maßgeblich zur Orientierung bei. LOUVER Insets sind die erste Wahl für Unterrichtsräume in Schulen und Universitäten, OPAL Insets sorgen in den Gängen für gleichmäßige Ausleuchtung.



190 lm/W system efficiency

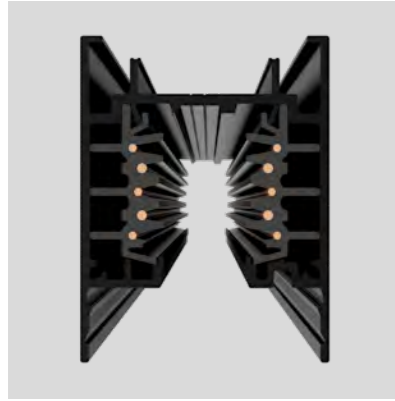

High quality optics

EN For maximum efficiency and precise light control, these light insets have been developed in-house using state-of-the-art technology. The most efficient LEDs, high-quality micro-faceted optics, and the latest converter technologies ensure excellent efficiency and optimal glare-free light distribution.

DE Für maximale Effizienz und präzise Lichtlenkung wurden diese Lichteinsätze inhouse auf dem neuesten Stand der Technik entwickelt. Die effizientesten LEDs, hochwertige microfacettierte Optiken und die neuesten Konverter-Technologien sorgen für einen exzellenten Wirkungsgrad und eine optimale blendfreie Lichtverteilung.

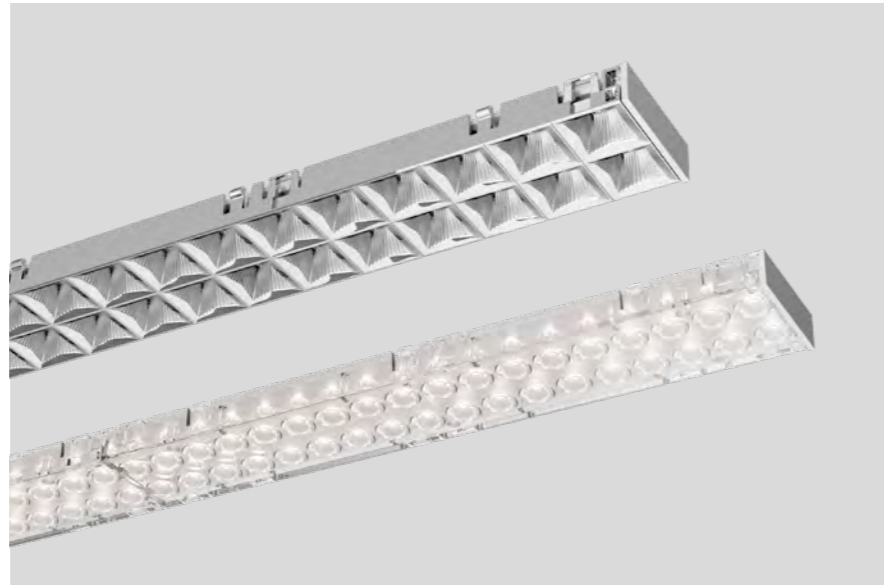

Powerful system

EN As a high-voltage 3-phase DALI track system with two additional emergency lighting circuits for integrating emergency signs and safety luminaires, MOVE IT PRO is highly efficient and versatile in its application.

DE Als Hochvolt 3-Phasen-DALI-Stromschienensystem mit zwei zusätzlichen Notlichtkreisen zur Integration von Rettungszeichen und Notlicht ist MOVE IT PRO nicht nur hocheffizient, sondern auch vielseitig in der Anwendung.

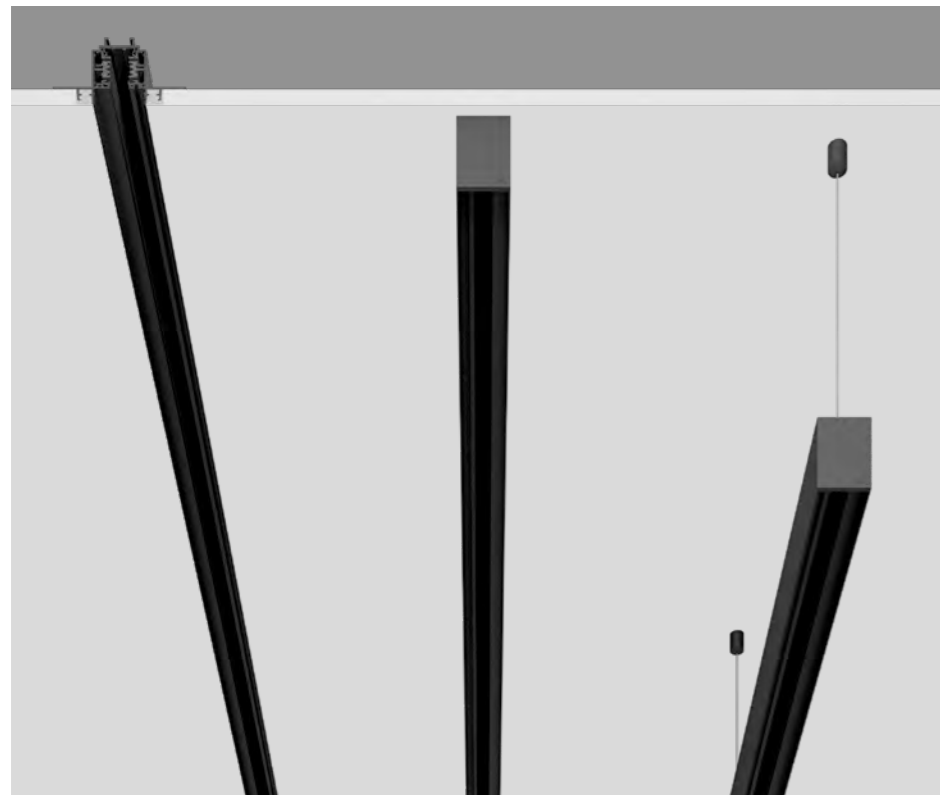

Mounting options

EN The MOVE IT PRO system offers a variety of mounting options: As a recessed or surface-mounted version for wall and ceiling installation, as well as suspended with direct and indirect light. These diverse versions facilitate a wide range of applications.

DE Das MOVE IT PRO System bietet eine Vielfalt an Montagemöglichkeiten: Als Einbau- oder Anbauvariante für Wand- und Deckenmontage sowie abgehängt mit Direkt- und Indirektlicht. Diese vielfältigen Ausführungen ermöglichen einen breiten Anwendungsbereich.

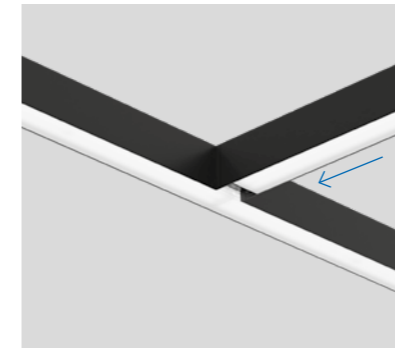
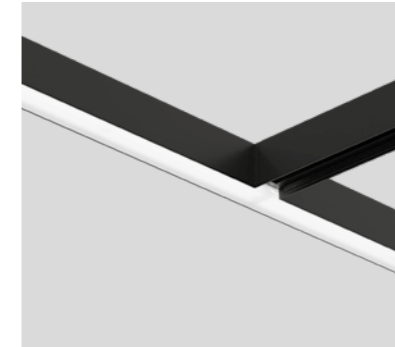
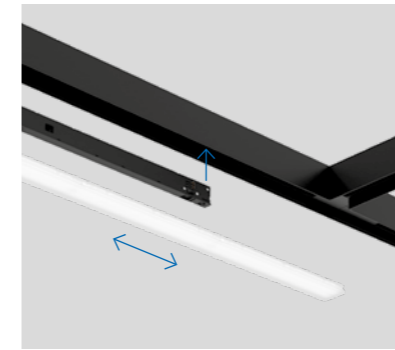

Linear insets freely positionable

EN Individual room concepts are accentuated by a seamless lighting system. Power adapters can be freely positioned along the track and supply up to three metres of linear insets. The insets can be used flexibly above the adapter and seamlessly connected to one another via plug-in connections.

DE Individuelle Raumkonzepte kommen durch ein lückenloses Lichtsystem besonders zur Geltung. Power Adapter können entlang der Stromschiene frei positioniert werden und bis zu drei Meter der Linearinsets versorgen. Die Insets können flexibel über dem Adapter eingesetzt und über Steckverbindungen nahtlos aneinandergereiht werden.

More flexibility

EN The direct and indirect insets can be flexibly mounted in the patented MOVE IT PRO system without tools and be freely arranged along the track. In this way, nothing stands in the way of simple mounting and spatial reorganisation.

DE Die Direkt- und Indirekt-Insets können flexibel in dem patentierten MOVE IT PRO System werkzeuglos montiert und entlang der Stromschiene frei arrangiert werden. So steht einer einfachen Montage und räumlicher Umgestaltung nichts mehr im Wege.

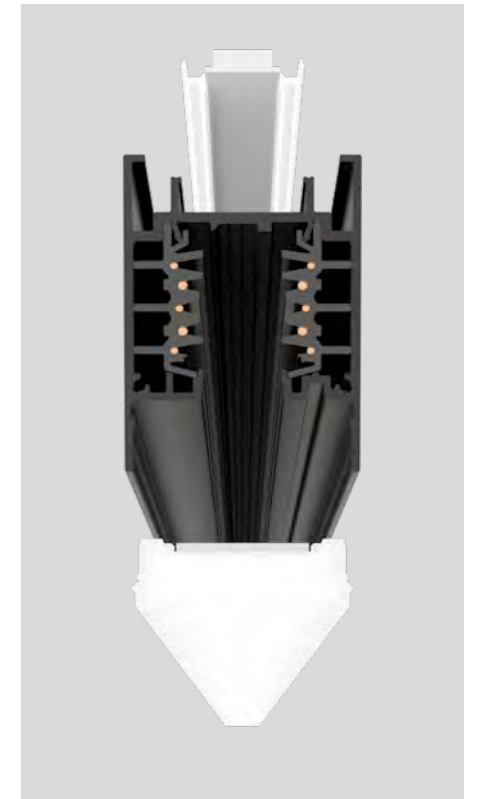

Connectors

EN The L-, T- and X-connectors give you planning freedom to realise individual room arrangements. The special feature: the linear insets can be positioned beyond the X-connectors and thus ensure continuous lighting.

DE Die L-, T- und X-Verbinder eröffnen Ihnen planerische Freiheit, individuelle Raumgestaltung umzusetzen. Das Besondere: die linearen Insets lassen sich über die X-Verbinder hinaus platzieren und sorgen somit für eine durchgängige Beleuchtung.

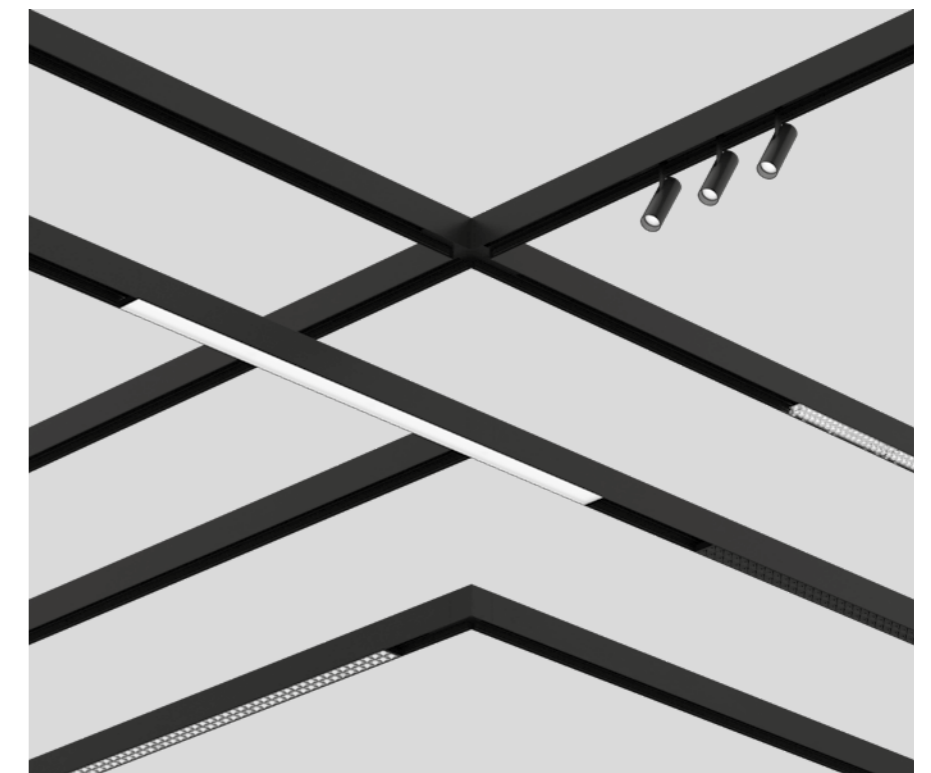

Inset variety

EN The wide selection of insets guarantees a versatile application of MOVE IT PRO. Whether OPAL for uniform general illumination, LOUVER, LENS, and SPOT LINE for workstations, or SHELF FLOOR WASHER for retail shelves – the selection offers a wide range of design options. TILA downlights and BO spotlights set accents, while the decorative NOBA and ARY insets provide additional highlights.

DE Ein vielseitiger Einsatz von MOVE IT PRO ist durch die große Auswahl an Insets garantiert. Ob OPAL für eine gleichmäßige allgemeine Ausleuchtung, LOUVER, LENS und SPOT LINE für Arbeitsplätze oder SHELF FLOOR WASHER für Regalflächen im Einzelhandel – die Auswahl bietet breite Gestaltungsmöglichkeiten. TARO Downlights und BO Strahler setzen Akzente, während die dekorativen NOBA und ARY Insets für zusätzliche Highlights sorgen.

Compatible spotlights

BO track
BO intrack (2 or 3 lamps)
SQUADRO
PABLO
VARO
VARO S
NOBA
ARY
TARO

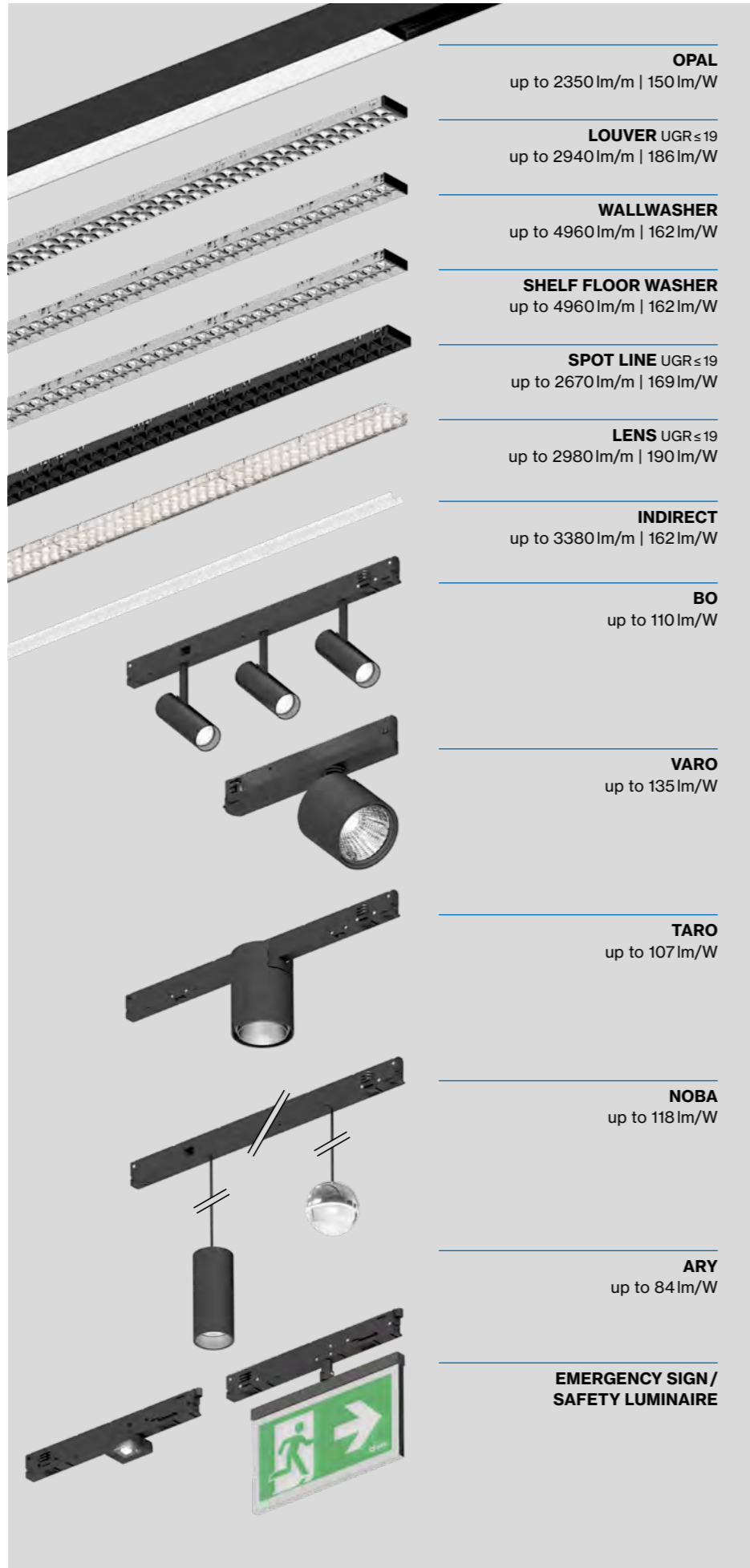

OPAL
up to 2350lm/m | 150lm/W

LOUVER UGR_{≤19}
up to 2940lm/m | 186lm/W

WALLWASHER
up to 4960lm/m | 162lm/W

SHELF FLOOR WASHER
up to 4960lm/m | 162lm/W

SPOT LINE UGR_{≤19}
up to 2670lm/m | 169lm/W

LENS UGR_{≤19}
up to 2980lm/m | 190lm/W

INDIRECT
up to 3380lm/m | 162lm/W

BO
up to 110lm/W

VARO
up to 135lm/W

TARO
up to 107lm/W

NOBA
up to 118lm/W

ARY
up to 84lm/W

**EMERGENCY SIGN/
SAFETY LUMINAIRE**

Advanced sensor technology

EN The addition of specially developed DALI sensors turns MOVE IT PRO into a smart-lighting system. The sensors can also be easily and flexibly integrated into the system later. The ESSENTIAL sensor adapts the lighting to the ambient brightness and room activity. The SENSE sensor also measures temperature, air quality, humidity, and noise levels. This data provides important information about the ambient conditions and supports long-term energy savings.

DE Durch die Erweiterung der eigens entwickelten DALI-Sensoren wird MOVE IT PRO zum smarten Beleuchtungssystem. Die Sensoren können einfach und flexibel auch nachträglich in das System integriert werden. Mittels ESSENTIAL Sensor passt sich die Beleuchtung an die Umgebungshelligkeit und Raumaktivität an. Mit dem SENSE Sensor werden ergänzend Werte zu Temperatur, Luftqualität, Luftfeuchtigkeit und Geräuschpegel gemessen. Diese Daten liefern wichtige Erkenntnisse über die Umgebungsbedingungen und unterstützen langfristig Energieeinsparungen.

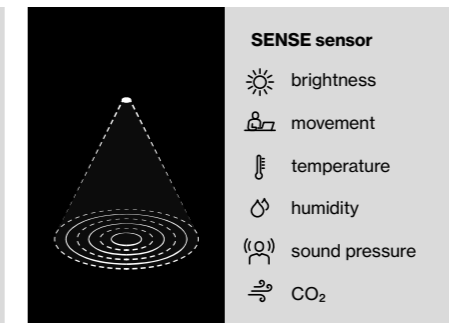
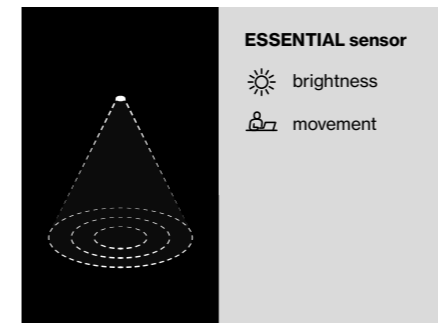
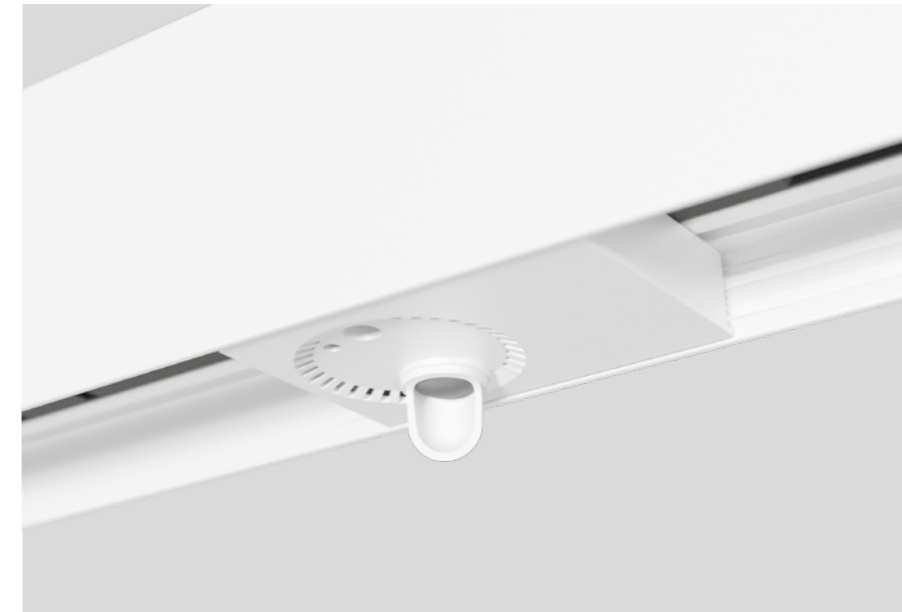

Indirect light

EN The 170° wide beam, indirect MOVE IT PRO light inset provides homogeneous ceiling illumination and creates a pleasant room atmosphere with a feel-good factor. The inset can be freely positioned in the track and can also be retrofitted.

DE Das 170° breit abstrahlende Indirektlicht-Inset von MOVE IT PRO sorgt für eine homogene Deckenaufhellung und schafft eine angenehme Raumatmosphäre mit Wohlfühlcharakter. Das Inset kann frei in der Stromschiene positioniert und auch nachträglich integriert werden.

Emergency sign & safety luminaire

EN The MOVE IT PRO 3-phase track system also offers two emergency lighting circuits for integrating emergency signs and safety luminaires from din – Dietmar Nocker Sicherheitstechnik GmbH & Co KG. These can also be easily integrated into the system later.

DE Das MOVE IT PRO 3-Phasen-Stromschienensystem bietet zusätzlich zwei Notlichtkreise zur Integration von Not- und Sicherheitsbeleuchtung der Firma din – Dietmar Nocker Sicherheitstechnik GmbH & Co KG. Diese können auch nachträglich einfach in das System integriert werden.



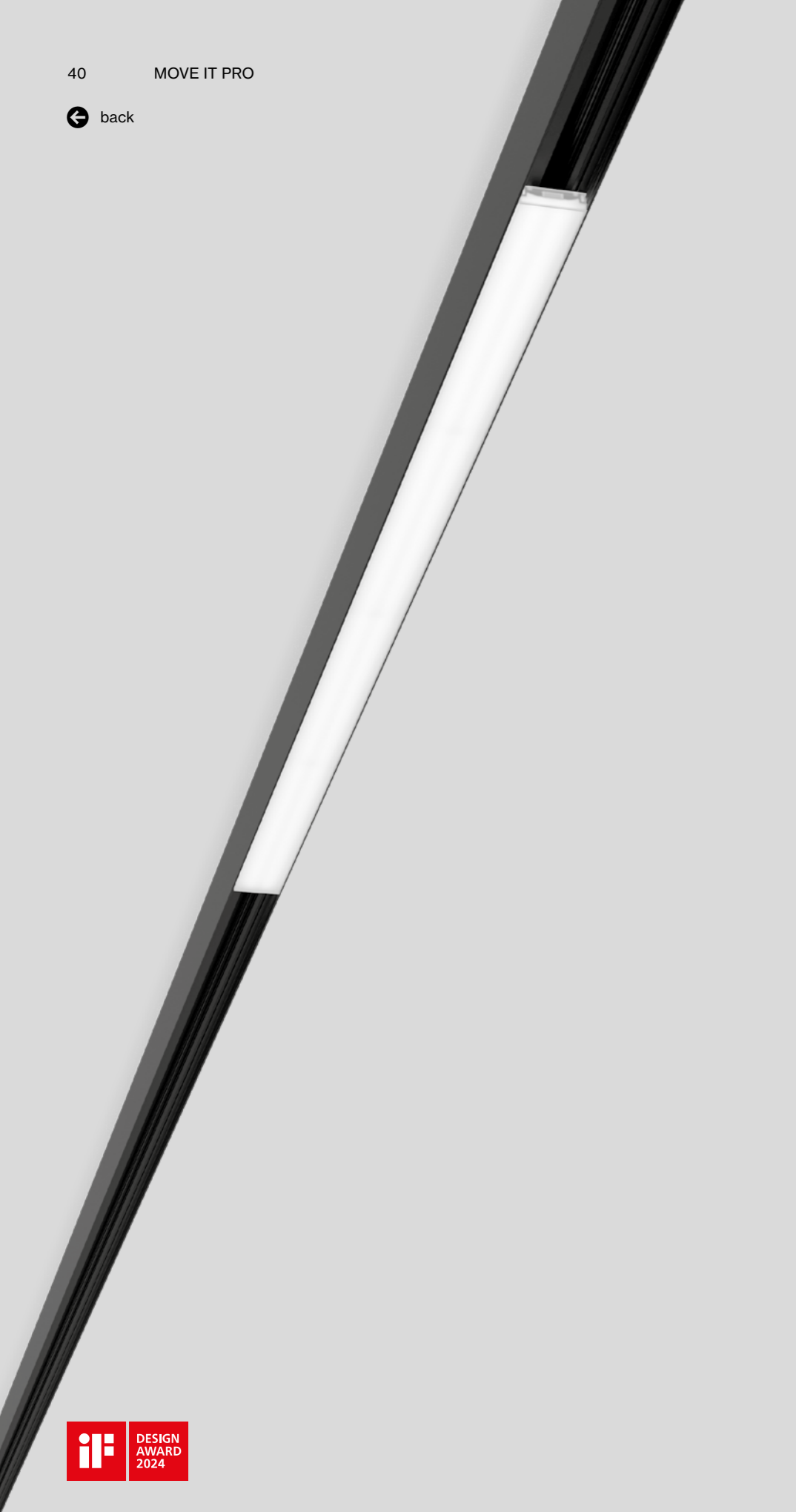

OPAL
linear inset

Quickinfo

3000K, 3500K, 4000 K
CRI ≥ 90, 3 SDCM
up to 150lm/W
up to 2350lm/m
L90 @ 50 000h
DALI-2

Types

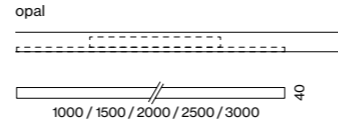

Colour



Light distribution



continuous cover



up to 150lm/W (high efficiency)



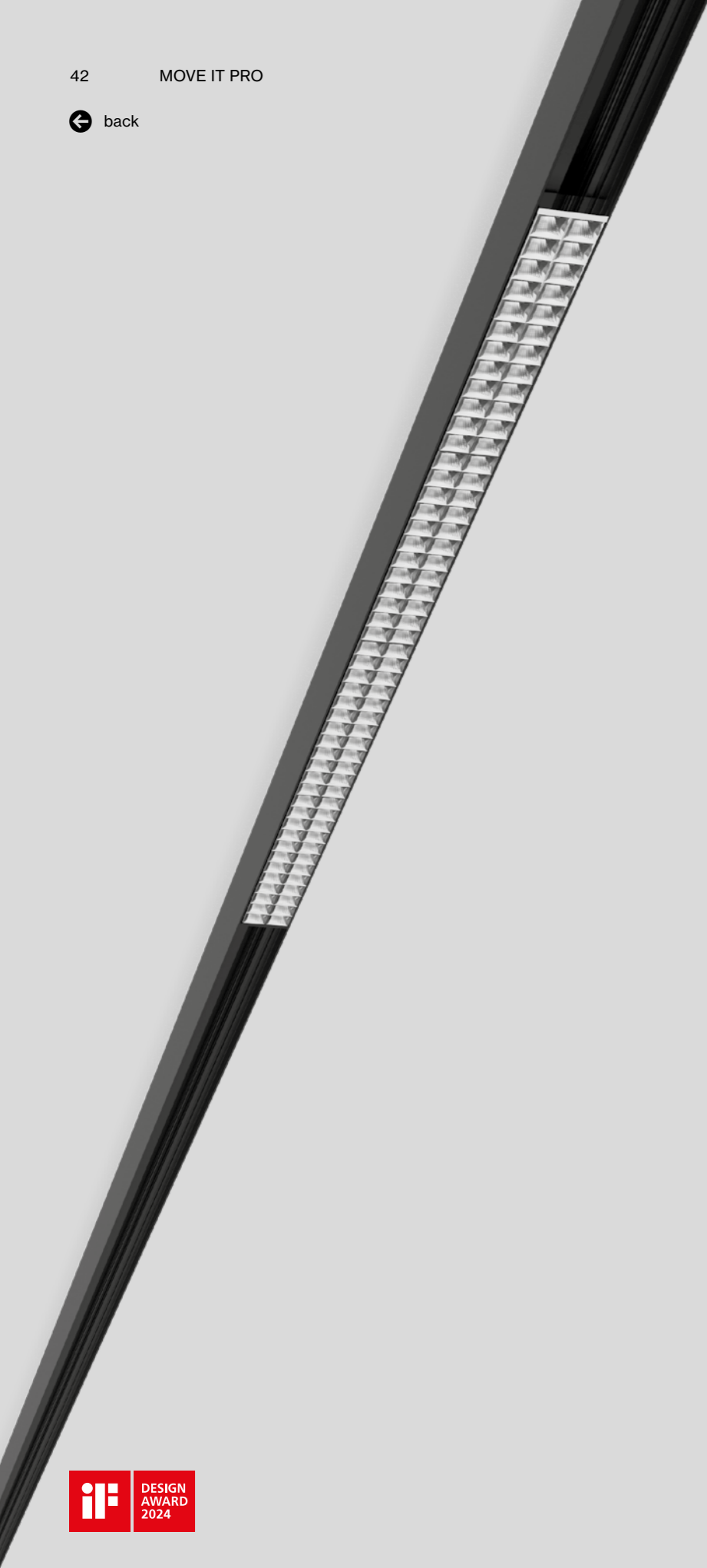

LOUVER
linear inset

Quickinfo

3000K, 3500K, 4000K
CRI ≥ 90, 3 SDCM
UGR ≤ 19 / 65° ≤ 3000 cd/m²
up to 186 lm/W
up to 2940 lm/m
L90 @ 50 000h
DALI-2

Types

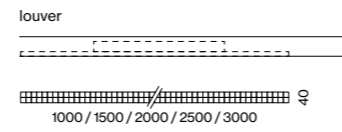

Colours



Light distribution

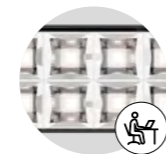

DIN EN 12464-1
UGR ≤ 19



up to 186 lm/W
(high efficiency)



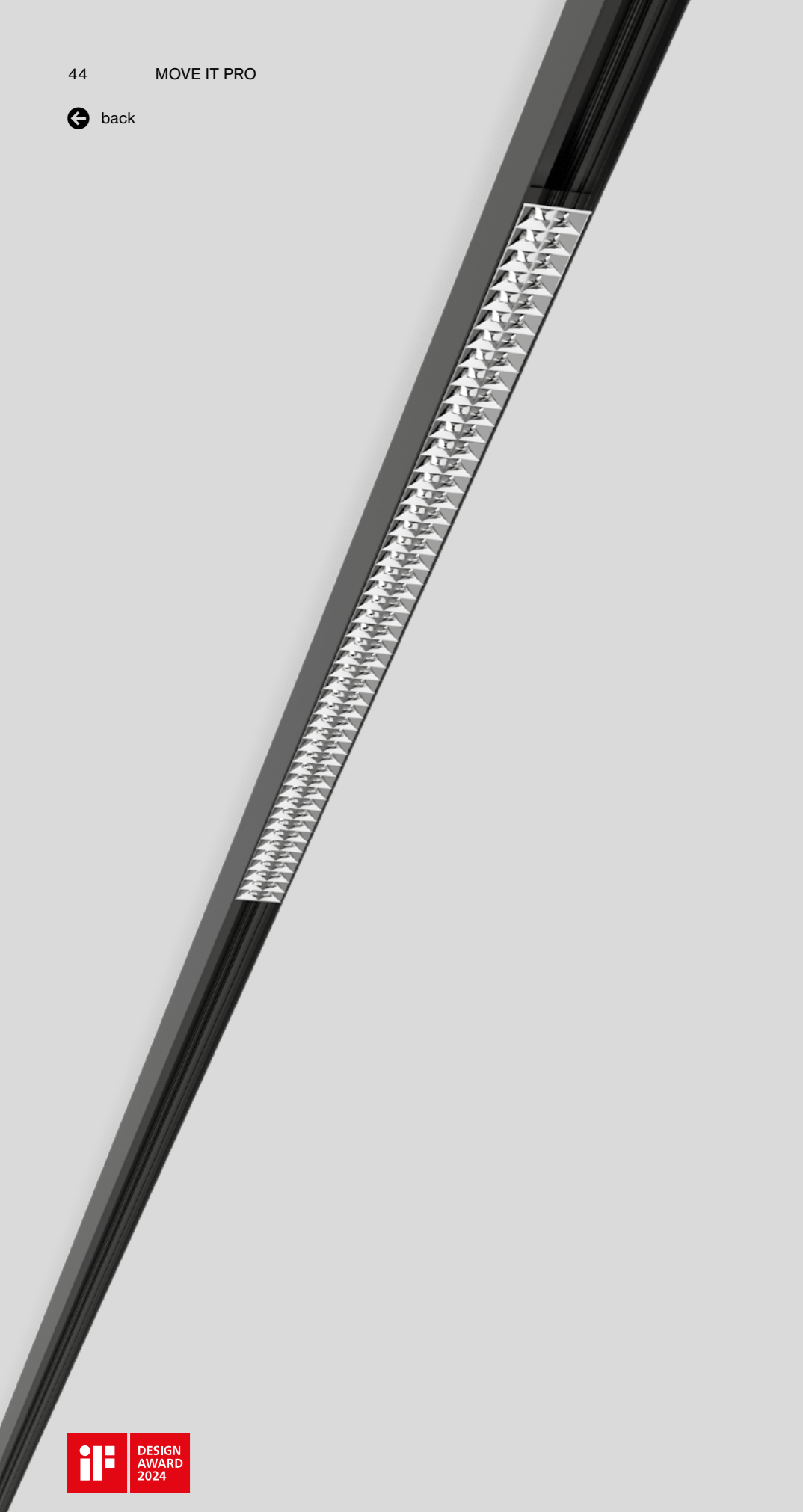

SHELF FLOOR WASHER

linear inset

Quickinfo

3000K, 3500K, 4000 K
CRI ≥ 90, 3 SDCM
up to 162lm/W
up to 4960lm/m
L90 @ 50 000h
DALI-2

Types

shelf floor washer

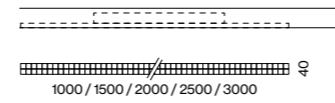

wallwasher

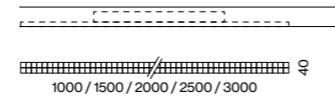

Colours



Light distributions



shelf floor washer 1-sided shelf floor washer 2-sided wall washer 1-sided

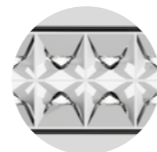

glare-free reflector longitudinally

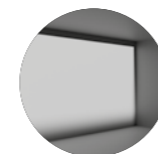

precision cut-off



up to 162lm/W (high efficiency)



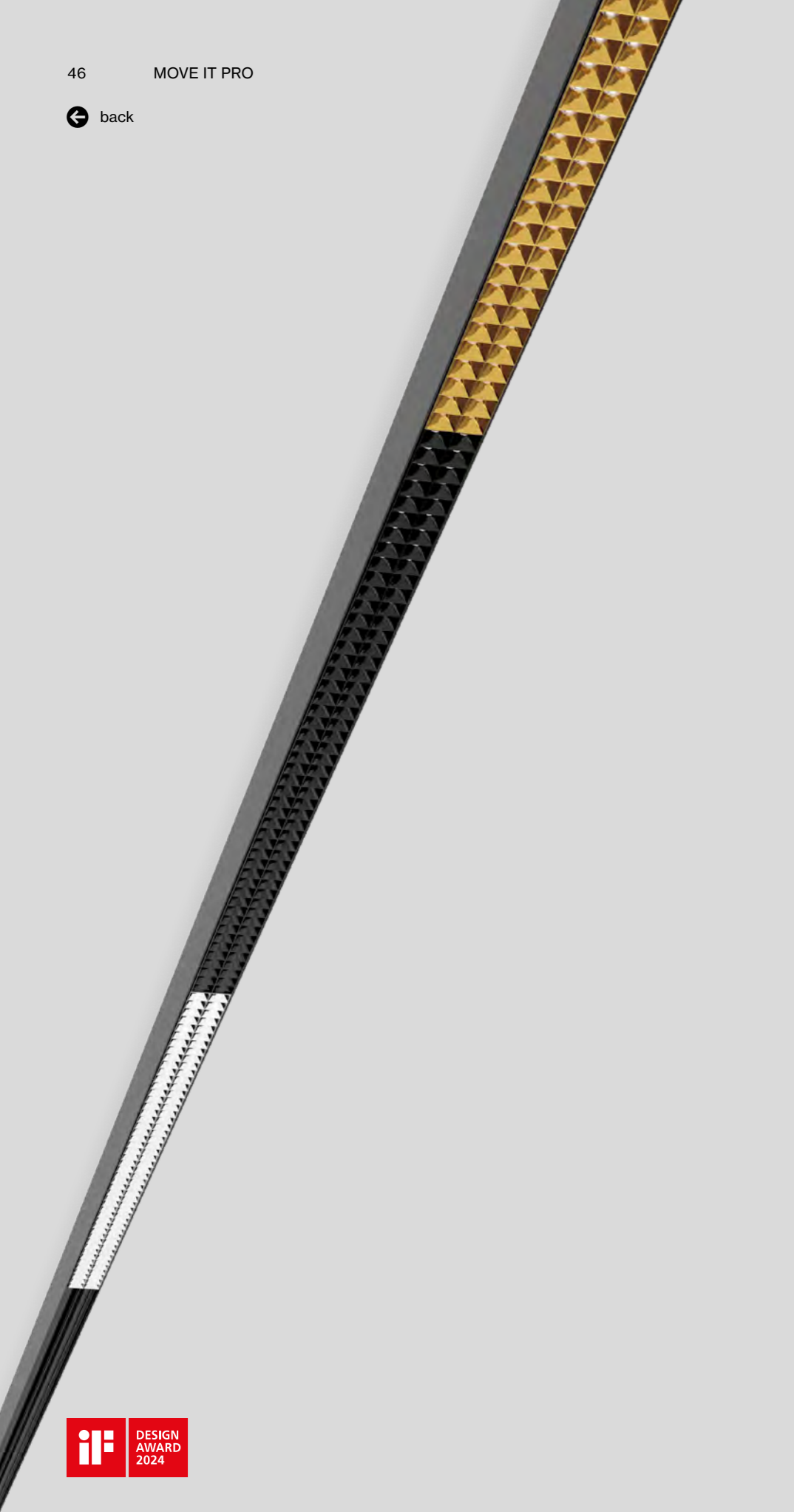

SPOT LINE
linear inset

Quickinfo

3000K, 3500K, 4000K
 CRI ≥ 90, 3 SDCM
 UGR ≤ 16 / 65° ≤ 3000 cd/m²
 up to 169 lm/W
 up to 2670 lm/m
 L90 @ 50 000h
 DALI-2

Types

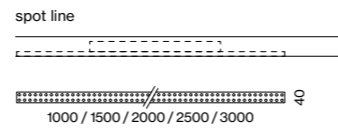

Colours



Light distributions

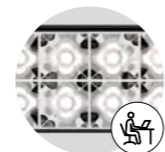

DIN EN 12464-1
UGR ≤ 16



up to 169 lm/W
(high efficiency)





LENS
linear inset

Quickinfo

3000K, 3500K, 4000 K
CRI ≥ 90, 3 SDCM
UGR ≤ 19 / 65° ≤ 3000 cd/m²
up to 190 lm/W
up to 2980 lm/m
L90 @ 50 000 h
DALI-2

Types

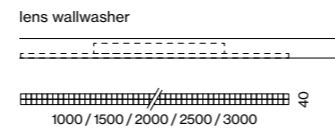
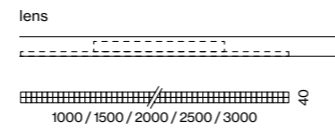

Colour



Light distributions



DIN EN 12464-1
UGR ≤ 19



up to 190 lm/W
(high efficiency)





Quickinfo

3000K, 3500K, 4000 K
CRI ≥ 90, 3 SDCM
up to 162lm/W
up to 3380lm/m
L90 @ 50 000h
DALI-2

Types

indirect

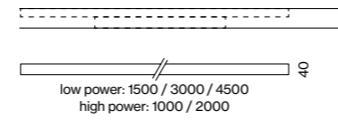

Colour



Light distribution



indirect



INDIRECT
linear inset

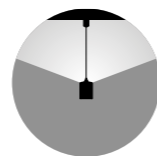

170° indirect illumination





TARO
spotlight inset

Quickinfo

2700 K, 3000 K, 3500 K, 4000 K
CRI ≥ 90, 2 SDCM
up to 107 lm/W
L80 @ 50 000 h
non DIM, DALI-2

Types

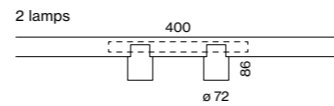
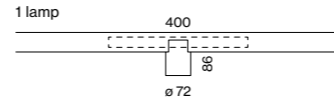

Colours



Light distributions



wallwasher and
ww floor inset



glare control
(UGR ≤ 16)



CWD
1800–3000 K



CRI ≥ 95
2 SDCM



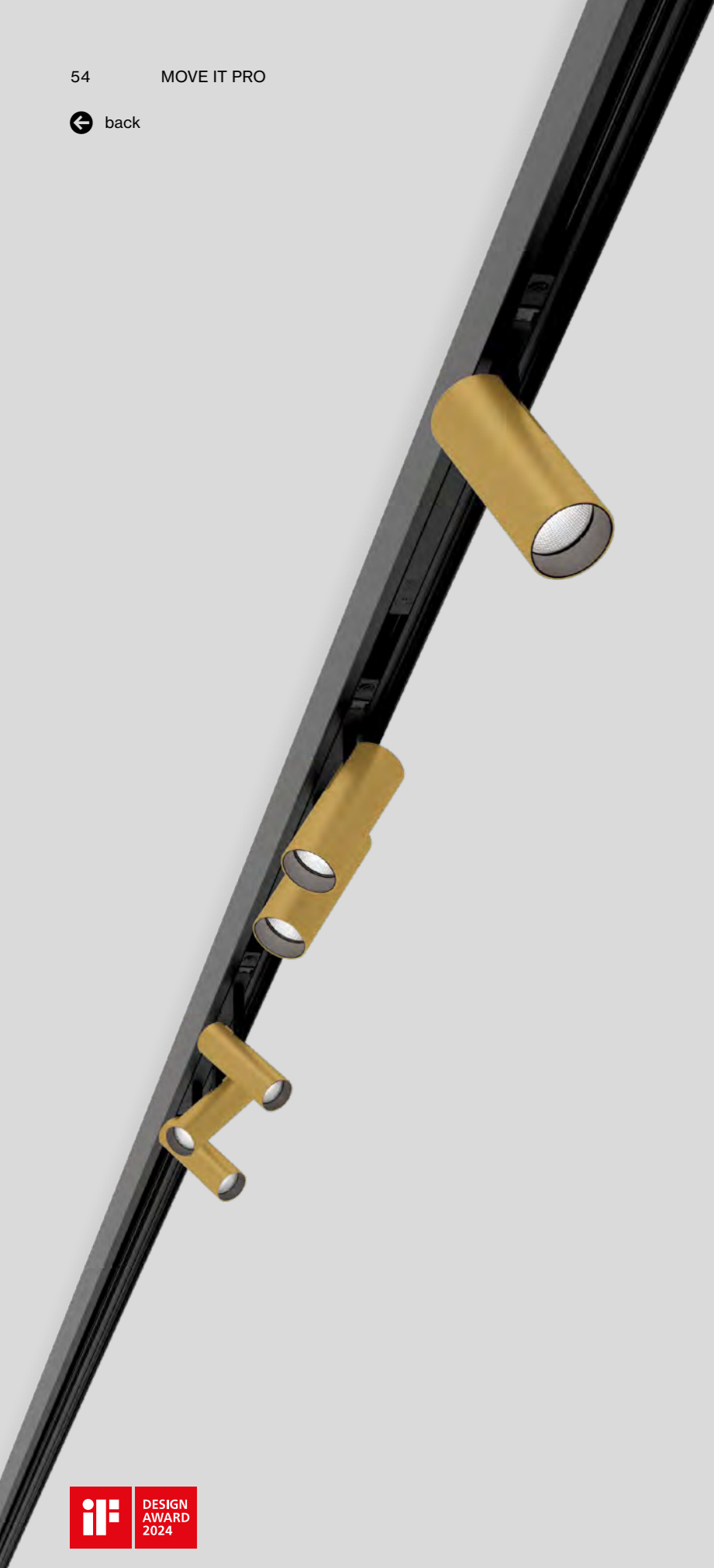

BO
spotlight inset

Quickinfo

2700 K, 3000 K, 3500 K, 4000 K
CRI ≥ 90, 2 SDCM
up to 110 lm/W
L80 @ 50 000 h
non DIM, DALI-2

Types

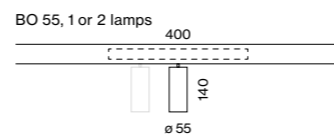
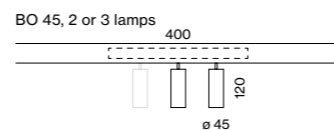
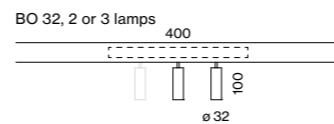

Colours



Light distributions

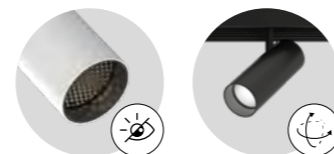

glare control via
honeycomb louver

360° rotatable
90° tiltable

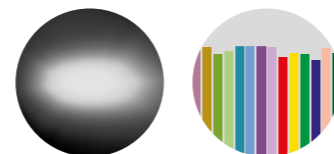

oval lens for oval
light illumination

CRI ≥ 95
2 SDCM



EuroShop Dusseldorf, DE –
by blocher partners



VARO S

spotlight inset

Quickinfo

3000K, 3500K, 4000 K
CRI ≥ 90, 3 SDCM
up to 135lm/W
L95 @ 50 000 h
non DIM, DALI-2

Types

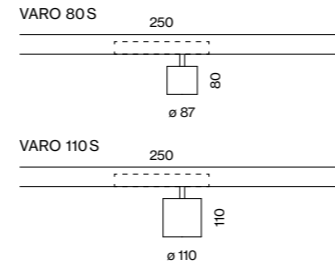

Colours



Light distributions

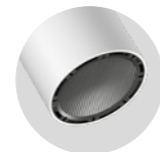
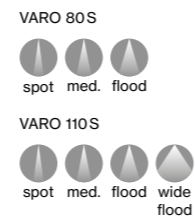

optical accessories



355° rotatable 90° tiltable



combine 2 optical accessories



up to 135lm/W (high efficiency)



Porsche Centre Saigon, VN - lighting design by Kobi Lighting Studio



Quickinfo

2700 K, 3000 K, 3500 K, 4000 K
 CRI ≥ 90, 2 SDCM
 up to 118 lm/W
 L80 @ 50 000 h
 DALI-2

Types

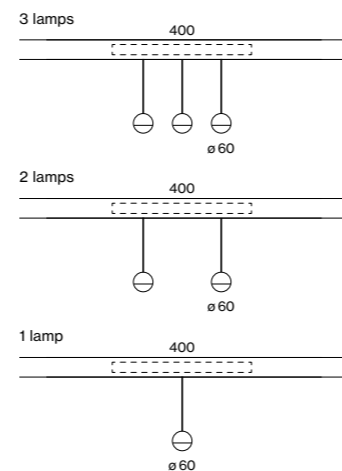

Colours



Light distribution

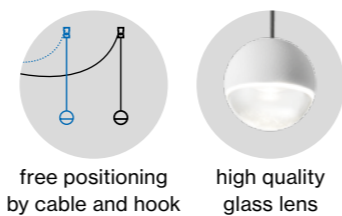

NOBA
 decorative inset





ARY
decorative inset

Quickinfo

2700 K, 3000 K, 4000 K
CRI ≥ 90, 3 SDCM
up to 84 lm/W
L90 @ 50 000h
non DIM, DALI-2

Types

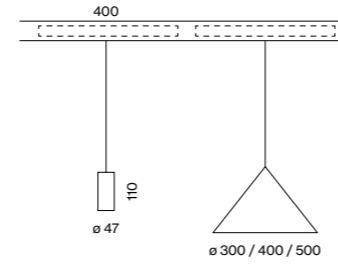

Colours

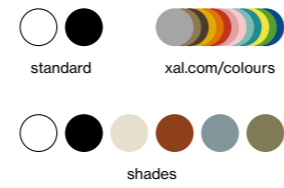

Light distributions

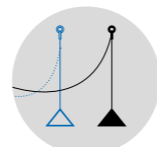

free positioning
by ring and hook



Kaffeekranz Lucerne, CH –
by hurrah GmbH with lighting design
by LICHTTEAM AG



EMERGENCY SIGN / SAFETY LUMINAIRE

emergency inset

Quickinfo

CRI ≥ 70
L80@50 000 h

Control options

- 24 V monitored and dimmable
- 230 V monitored
- single battery with automatic test
- single battery radio control monitored

Types

EMERGENCY SIGN string 1

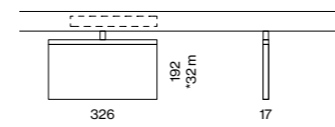
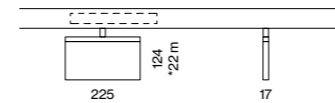

EMERGENCY SIGN string 2

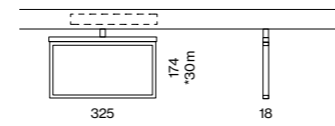
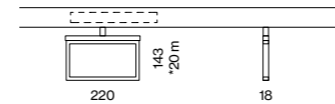

EMERGENCY SIGN concept 2 sign

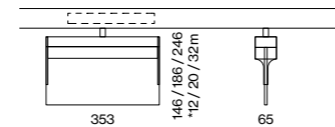

*viewing distance

EMERGENCY SIGN concept 2 emergency light

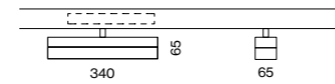

SAFETY LUMINAIRE

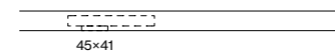

- escape route
- spot
- anti-panic

Colours



easy system integration

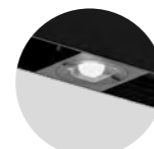

safety luminaire flush mounted



Light in three dimensions

CONEX system

EN The CONEX connectors (patent pending) deliver absolute lighting design freedom. The connecting elements in L-, T- and X-shapes can be combined as required with TUBO 60, TUBIN 60, SETA 60, and SETA track system luminaires. The Flex Connector also offers the freedom to create connections at 90° angles, which gives CONEX designers even more design freedom over several levels and facilitates unusual lighting sculptures. The simple plug-in system allows quick installation by connecting individual elements mechanically and electrically in just a few steps.

DE Die zum Patent angemeldeten CONEX Verbinder schaffen absolute Gestaltungsfreiheit in der Lichtplanung. Die Verbindungselemente in L-, T- und X-Form lassen sich beliebig mit TUBO 60, TUBIN 60, SETA 60 und SETA track Systemleuchten kombinieren. Der Flex-Connector bietet zusätzlich die Freiheit, aus Verbindungen im 90° Winkel auszubrechen, welcher der Planung mit CONEX nochmal mehr Gestaltungsspielraum über mehrere Ebenen bietet und ausgefallene Lichtskulpturen ermöglicht. Das einfache Stecksystem erlaubt eine schnelle Montage, indem einzelne Elemente mechanisch und elektrisch in wenigen Schritten verbunden werden.

Types



TUBO 60 TUBIN 60 SETA 60

Mountings

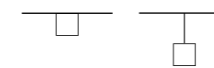

surface suspended

Configurations



linear L T X flex

Light distributions



opal reflector (UGR ≤ 19) direct direct indirect indirect

CONEX luminaires & track

EN The CONEX system fulfils a wide range of lighting requirements with just one system. It can be combined with TUBO 60 for homogeneous lighting and with TUBIN 60 elements for a special effect. For optimum office lighting, CONEX combines the SETA 60 system luminaires with SETA track and also with various insets for even more flexibility in lighting design.

DE Das CONEX System erfüllt unterschiedlichste Lichthanforderungen mit nur einem System. Für eine homogene Beleuchtung kann es mit TUBO 60 und für ein besonderes Erscheinungsbild mit TUBIN 60 Elementen kombiniert werden. Für die optimale Büroraumbeleuchtung verbindet CONEX die SETA 60 Systemleuchten – mit SETA track auch mit verschiedenen Insets für noch mehr Flexibilität in der Lichtplanung.

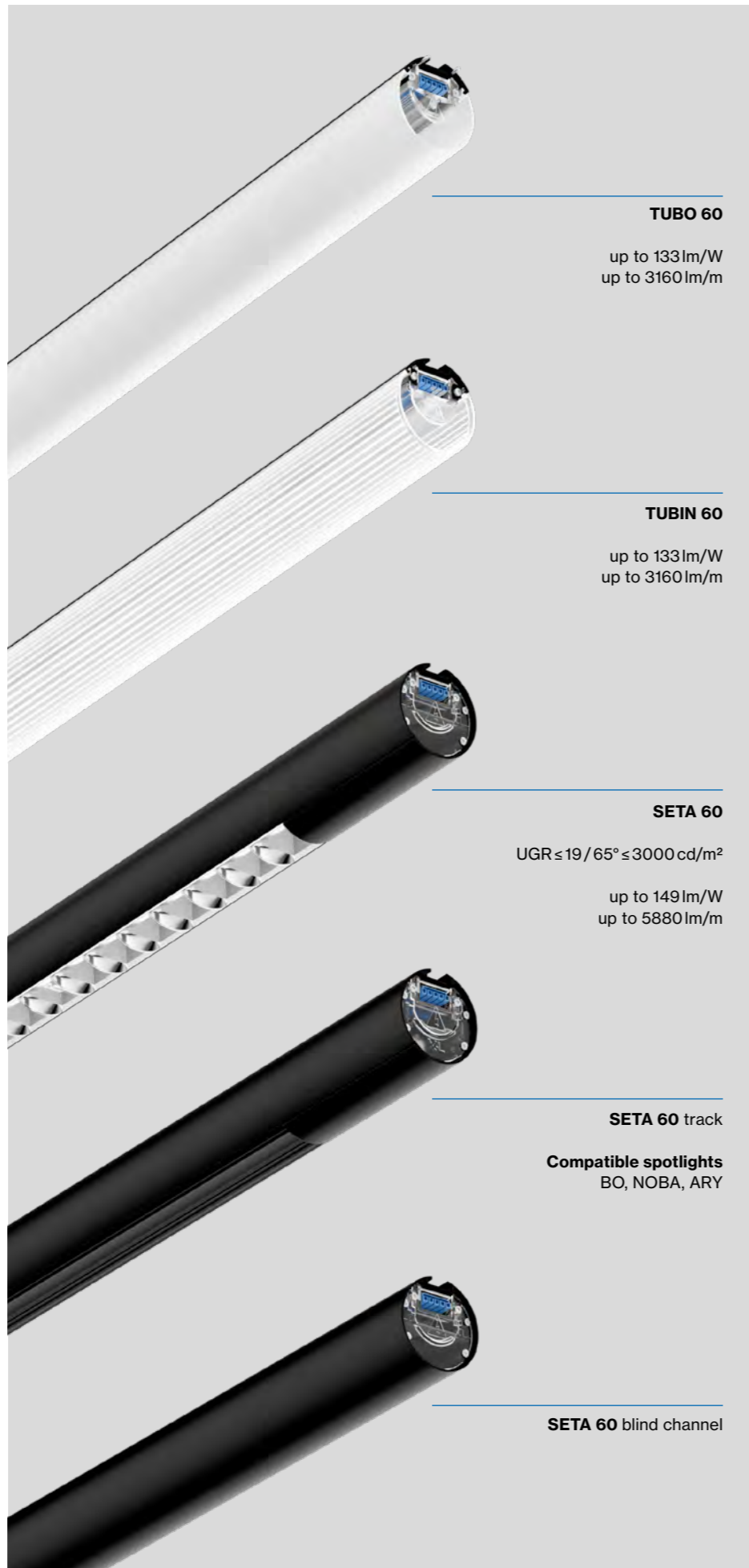

TUBO 60

up to 133 lm/W
up to 3160 lm/m

TUBIN 60

up to 133 lm/W
up to 3160 lm/m

SETA 60

$UGR \leq 19 / 65^\circ \leq 3000 \text{ cd/m}^2$

up to 149 lm/W
up to 5880 lm/m

SETA 60 track

Compatible spotlights
BO, NOBA, ARY

SETA 60 blind channel

CONEX L-, T-, X-connector

EN Thanks to the wide range of mechanical and electrical connecting elements in L-, T- and X-shapes, there is the greatest possible design freedom. Geometric shapes, fascinating light sculptures, and the fulfilment of different spatial requirements are easy to implement thanks to the CONEX connection system.

DE Dank der vielfältigen mechanischen und elektrischen Verbindungselemente in L-, T- und X-Form ergibt sich größtmöglicher Gestaltungsfreiraum. Geometrische Formen, spannende Lichtskulpturen und das Erfüllen unterschiedlicher räumlicher Anforderungen sind dank dem CONEX Verbindungssystem einfach umsetzbar.

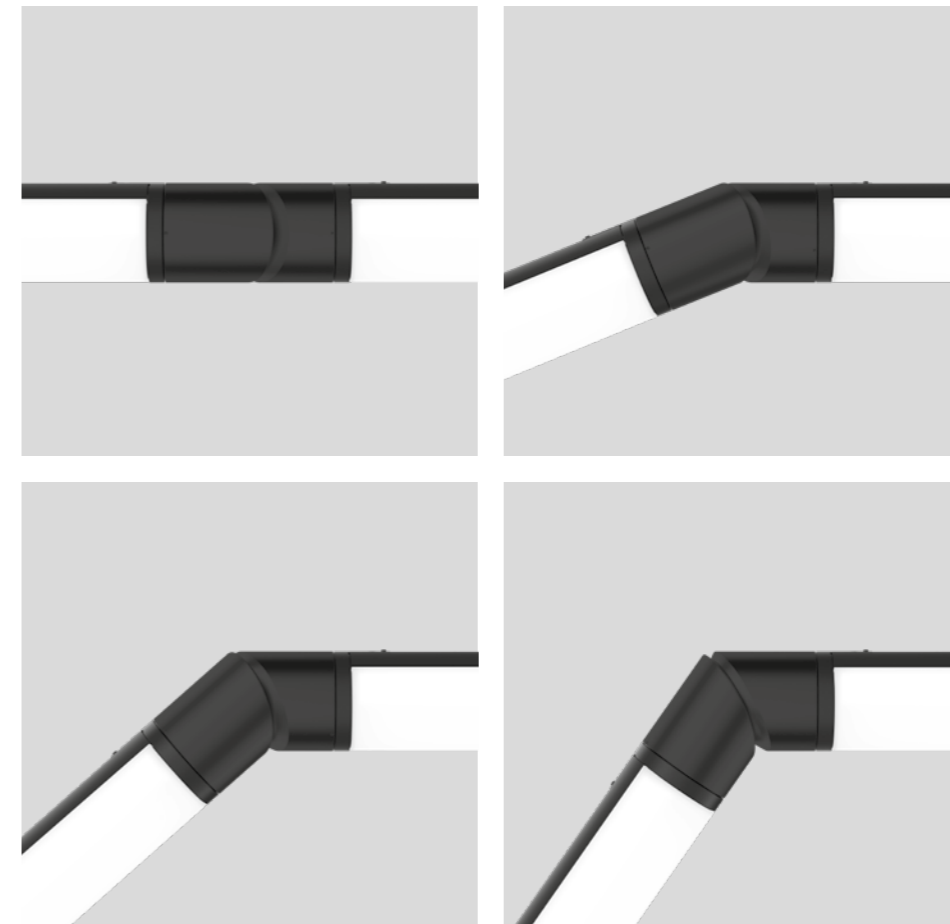
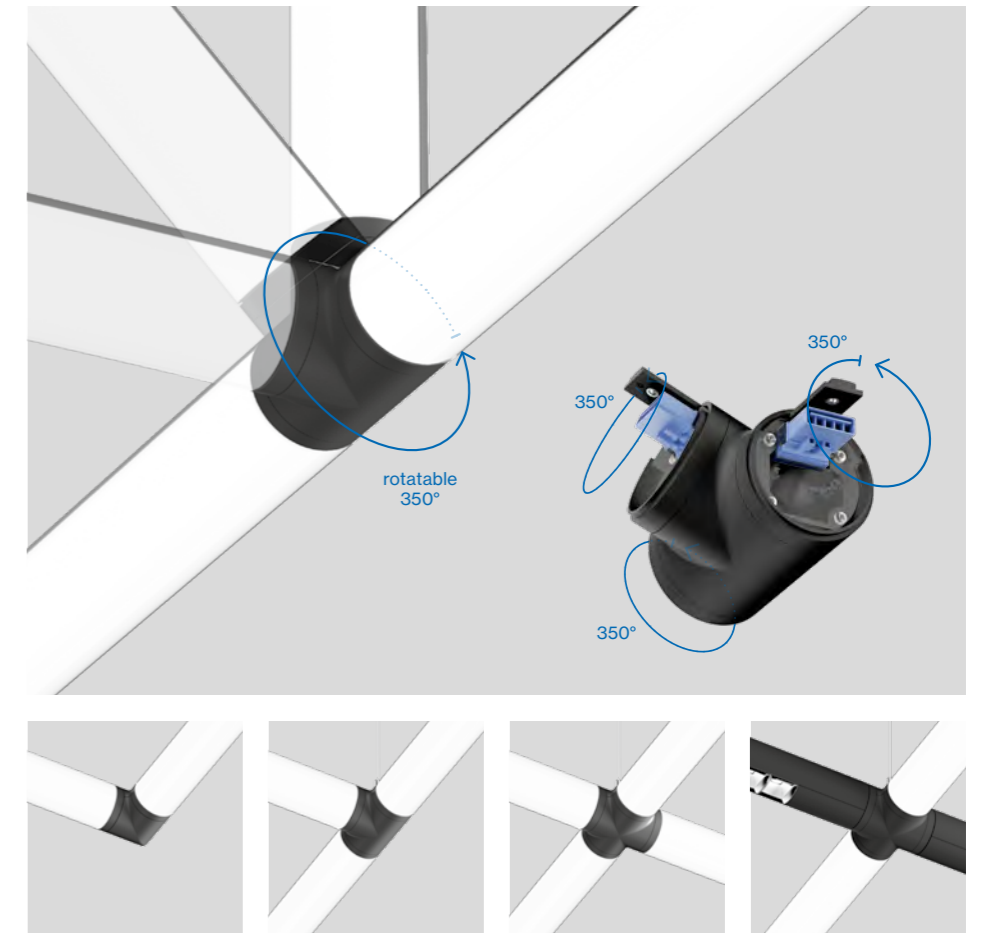

CONEX flex connector

EN The Flex Connector, which can be rotated through 350° and swivelled up to 60°, connects several levels beyond 90°. Three-dimensional connections and exciting light sculptures can thus seamlessly illuminate rooms.

DE Der um 350° drehbare und bis zu 60° schwenkbare Flex-Connector verbindet mehrere Ebenen über 90° hinausgehend. Dreidimensionale Verbindungen und spannende Lichtskulpturen können so Räume nahtlos zum Strahlen bringen.

Easy mounting

EN CONEX system luminaires are connected electrically and mechanically using a simple plug-in connection. This makes the installation of a complex lighting system extremely simple, quick, and straightforward.

DE CONEX Systemleuchten werden durch eine simple Steckverbindung elektrisch und mechanisch verbunden. Dadurch ist die Montage eines komplexen Lichtsystems denkbar einfach, rasch und unkompliziert durchführbar.

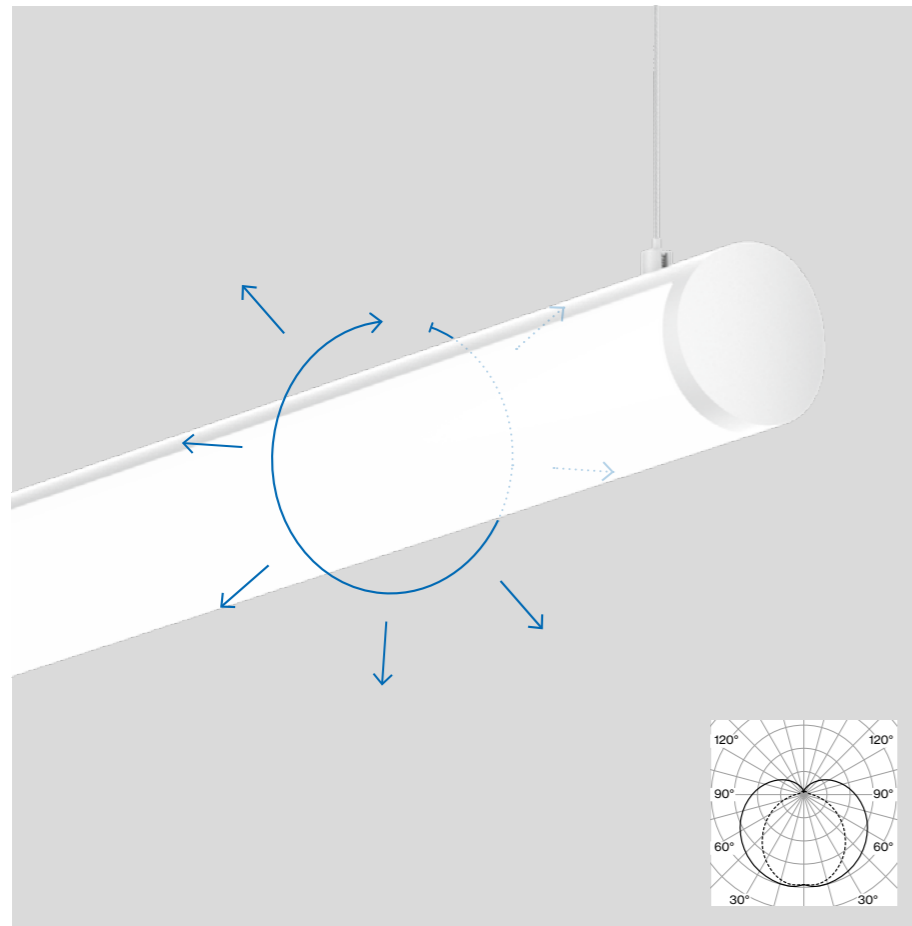

340° light distribution

EN Thanks to the 340° light distribution and opal cover, the TUBO system luminaire achieves homogeneous lighting and a slight brightening of the ceiling. This makes the system luminaire perfect for places where pleasant ambient lighting is required, such as reception areas, corridors, or foyers.

DE Durch die 340° Abstrahlcharakteristik und Opal-Abdeckung erzielt TUBO Systemleuchte eine homogene Beleuchtung sowie eine leichte Deckenaufhellung. Dadurch ist die Systemleuchte perfekt geeignet für Orte, an denen eine angenehme Grundausleuchtung gewünscht ist, wie Empfangsbereiche, Flure oder Foyers.



TUBIN 60 with lens/clear cover

Work-friendly light

EN As an office luminaire, SETA guarantees standard-compliant illumination of workstations (up to $UGR \leq 16$). Specially glare-reduced reflectors and the targeted application of blind covers direct the light precisely onto the work surface and reduce reflections. The optional indirect version uses special lens technology to distribute the very wide indirect light component homogeneously on the ceiling.

DE SETA als Office-Leuchte garantiert eine normgerechte Ausleuchtung von Arbeitsplätzen (bis zu $UGR \leq 16$). Speziell entblendete Reflektoren und der gezielte Einsatz von Blind-Covers richten das Licht zielgenau auf die Arbeitsfläche und reduzieren Spiegelungen. Die wahlweise Indirektausführung verteilt mittels einer speziellen Linsentechnik den sehr breit ausstrahlenden Indirektlichtanteil homogen an der Decke.



Advanced sensor technology

EN Special sensors add smart lighting control to the SETA product family. The ESSENTIAL sensors facilitate dynamic adjustment of the lighting to the ambient brightness and room activity. The SENSE version also measures values such as temperature, air quality, humidity, and noise level. This data provides important insights into the ambient conditions and utilisation of rooms while also supporting long-term energy savings.

DE Spezielle Sensoren erweitern die Produktfamilie SETA um smarte Lichtsteuerung. Der ESSENTIAL-Sensor ermöglicht die dynamische Anpassung der Beleuchtung an Umgebungshelligkeit und Raumaktivität. Die SENSE-Variante misst außerdem Werte wie Temperatur, Luftqualität, Luftfeuchtigkeit und Geräuschpegel. Diese Daten liefern nicht nur wichtige Erkenntnisse über die Umgebungsbedingungen und Nutzung von Räumen, sondern unterstützen langfristig Energieeinsparungen.

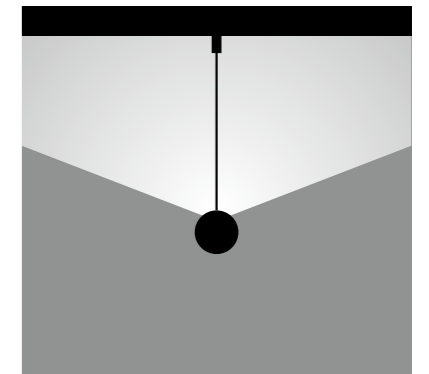

Indirect version

EN SETA's indirect and direct/indirect variant with its 170° wide indirect light distribution ensures homogeneous ceiling illumination and therefore a pleasant feeling of space and work atmosphere.

DE Die indirekt und direkt/indirekt Variante der SETA sorgt mit ihrem 170° breiten abstrahlenden Indirektlichtanteil für eine homogene Deckenaufhellung und damit für ein angenehmes Raumgefühl und Arbeitsatmosphäre.



Quickinfo

3000K, 4000K
CRI ≥ 80, 3 SDCM
up to 133lm/W
up to 3160 lm/m
L90@50000h
DALI-2
opal

Types

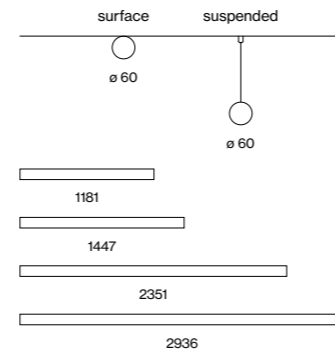

CONEX connector

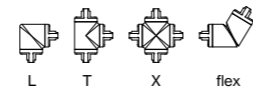

Colours



Light distributions

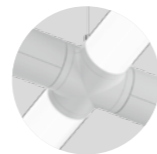

combinable with
TUBIN & SETA

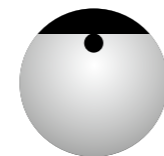

340° uniform
illumination



up to 133lm/W
(high efficiency)



reddot winner 2023



CONEX/TUBO 60 system
surface / suspended

← back

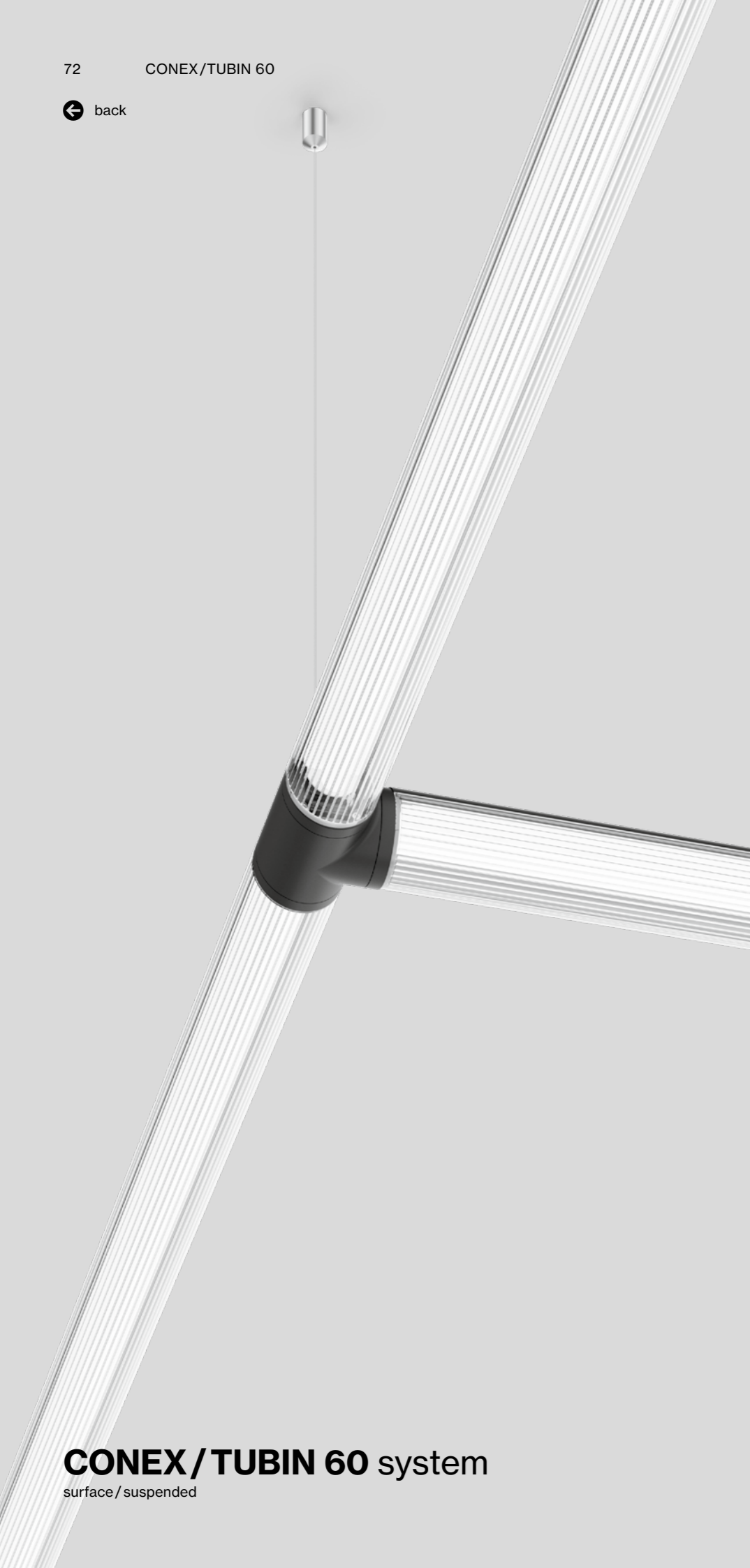

CONEX/TUBIN 60 system

surface / suspended

Quickinfo

3000K, 4000K
 CRI ≥ 80, 3 SDCM
 up to 133lm/W
 up to 3160 lm/m
 L90@50 000h
 DALI-2
 lens / clear cover

Types

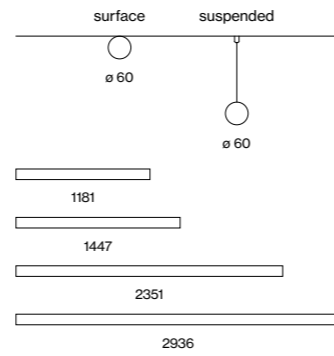

CONEX connector

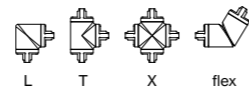

Colours



Light distributions

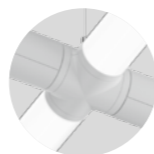

combinable with
TUBO & SETA

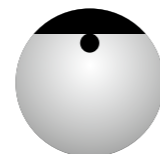

340° uniform
illumination



up to 133lm/W
(high efficiency)



← back



reddot winner 2023



CONEX/SETA 60 system

surface / suspended

Quickinfo

3000K, 4000K
CRI ≥ 80, 3 SDCM
UGR ≤ 19 / 65° ≤ 3000 cd/m²
up to 149 lm/W
up to 5880 lm/m
L90@50 000 h
DALI-2
reflector (UGR ≤ 19)

Types

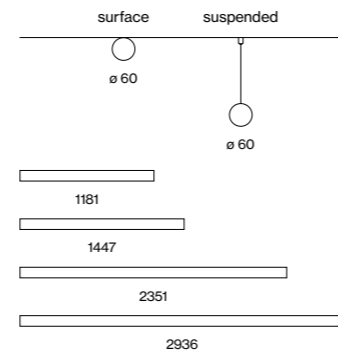

CONEX connector

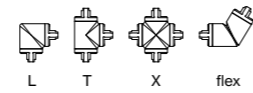

Colours



Light distributions

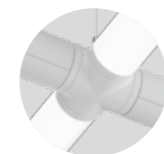
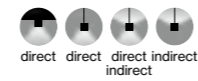

combinable with TUBO & TUBIN



DIN EN 12464-1 UGR ≤ 19

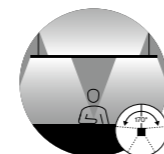

direct and 170° indirect illumination



up to 149 lm/W (high efficiency)















Spotlight your profile



FRAME/MINO 40 system

EN With the FRAME 40 and MINO 40 profile system, lighting designs can be customised to suit all requirements. The Flex Insets, specially developed for the system, can be shortened directly on-site; the corner connectors facilitate a continuous strip light. Combined with opal or microprismatic covers, the insets create pleasant ambient lighting while the wallwasher insets provide additional wall illumination. In addition, the reflector insets can be used for workstations and individual spotlights for customised accents.

DE Die Lichtplanung kann mit dem FRAME 40 und MINO 40 Profilsystem an alle Gegebenheiten angepasst werden. Die für das System speziell entwickelten Flex-Insets können direkt vor Ort gekürzt werden und die Eckverbinder ermöglichen ein durchgängiges Lichtband. Die Insets, kombiniert mit opal oder microprismatischen Cover, schaffen eine angenehme Grundausleuchtung und das Wallwasher-Inset sorgt für eine zusätzlich Wandaufhellung. Ergänzend können die Reflektor-Insets für Arbeitsplätze und einzelne Spots für individuelle Akzente eingesetzt werden.

Type						
	40					
Mountings						
	with trim recessed	surface	suspended			
Configurations						
	linear	corner				
Light distributions						
	opal	micro-prismatic	reflector (UGR ≤ 19)	direct	spotlight	wallwasher floor

Flexibility

EN The FRAME and MINO profile systems with an integrated high-voltage DALI track facilitate the simple insertion of spots and linear insets via the snap-in system (patent pending), which allows flexible planning and easy installation and maintenance.

DE Die FRAME und MINO Profilsysteme mit integrierter Hochvolt DALI-Stromschiene ermöglichen über das zum Patent angemeldete Snap-In System ein einfaches Einsetzen von Spots und linearen Insets, welches eine flexible Planung und eine einfache Montage sowie Wartung erlaubt.



snap-in system
(patent pending)

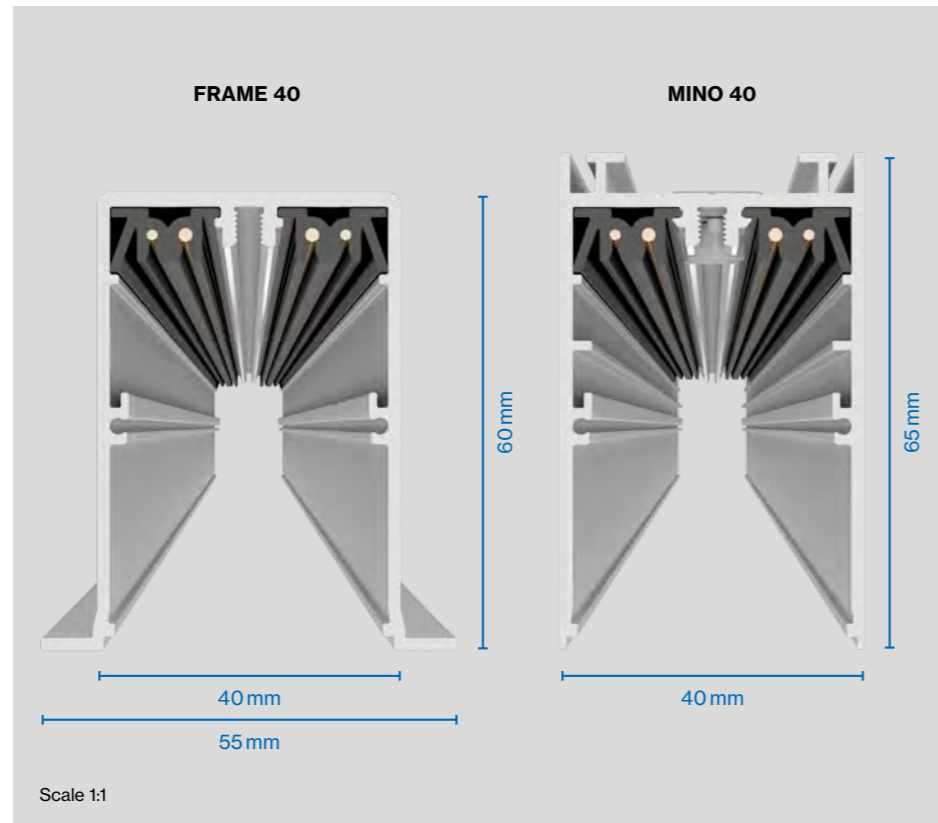

Mounting options

EN The FRAME 40 and MINO 40 profile system offers a wide range of mounting options: As recessed, surface-mounted, and suspended versions. The suspended direct/indirect variant provides additional homogeneous ceiling illumination.

DE Das FRAME 40 und MINO 40 Profilsystem bietet eine große Vielfalt an Montagemöglichkeiten: Als Einbau- und Anbauvariante sowie als abgehängte Version. Die abgehängte direkt/indirekt Variante sorgt für eine zusätzliche homogene Deckenaufhellung.

Easy mounting

EN FRAME/MINO 40 is a profile system with an integrated track that facilitates flexible planning and easy installation and maintenance.

- 1 Two profiles are simply connected to each other using mechanical and electrical connectors.
- 2 Thanks to the snap-in system (patent pending), the spots and linear insets can be quickly and easily inserted into the track and repositioned as required.
- 3 The covers of the linear insets can be easily inserted into the profile. The Continuous Cover can also be adapted to the respective profile length on site.

DE FRAME/MINO 40 ist ein Profilsystem mit integrierter Stromschiene, welches eine flexible Planung und eine einfache Montage sowie Wartung ermöglicht.

- 1 Mittels mechanischer und elektrischer Verbinder werden zwei Profile einfach miteinander verbunden.
- 2 Durch das, zum Patent angemeldete, Snap-In System lassen sich die Spots und linearen Insets schnell und unkompliziert in die Stromschiene einsetzen und nach Belieben neu platzieren.
- 3 Die Abdeckungen der linearen Insets lassen sich einfach im Profil einsetzen. Das Continuous Cover kann zusätzlich nach Bedarf vor Ort auf die jeweilige Profillänge angepasst werden.

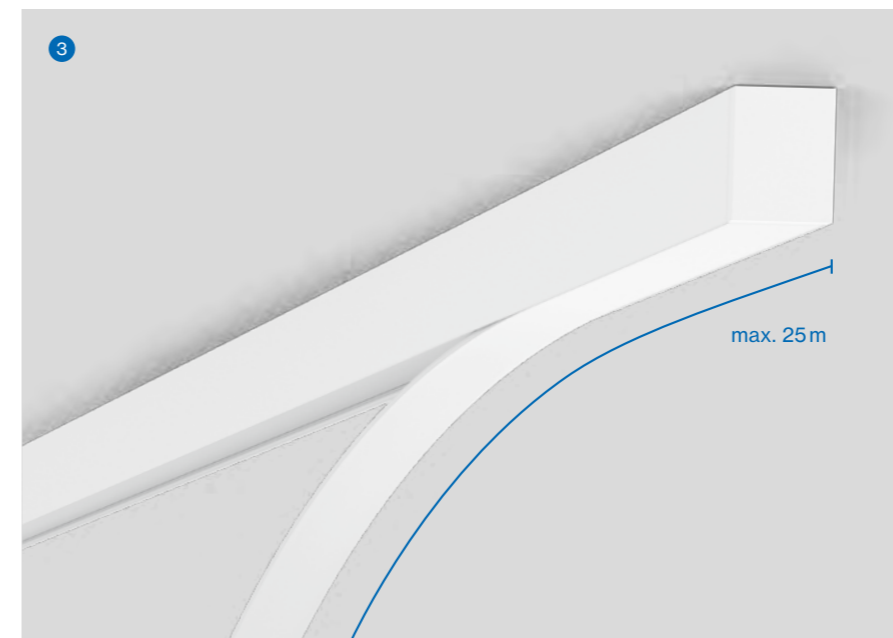
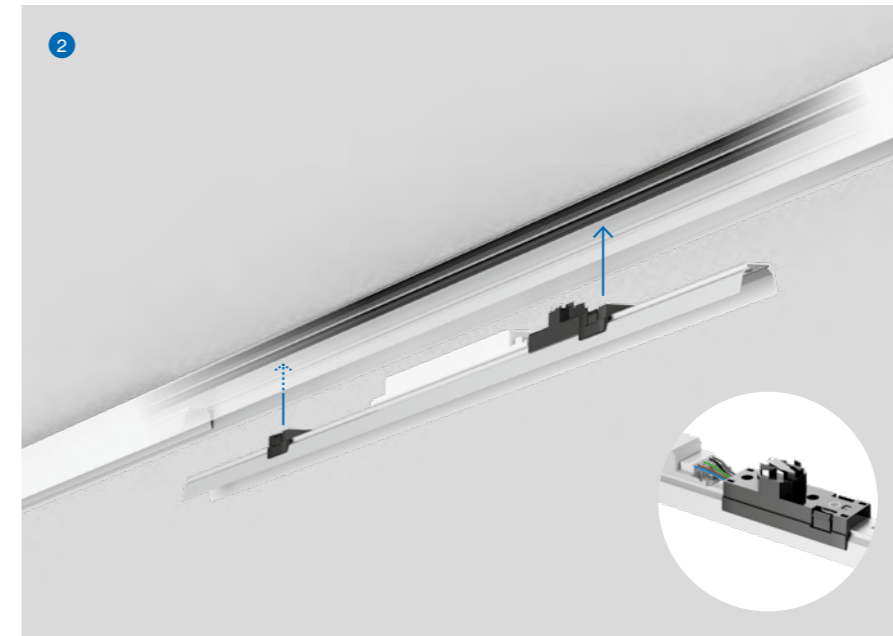
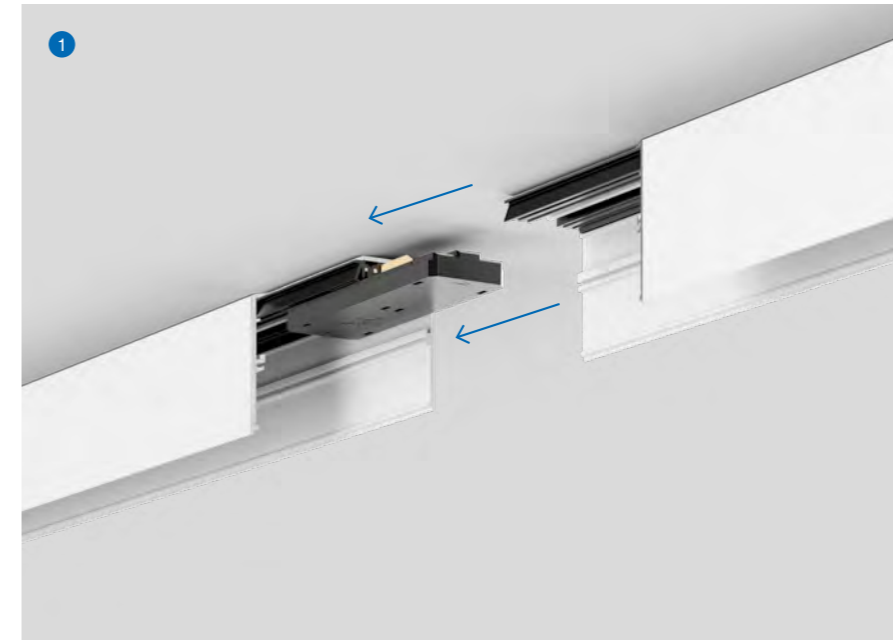

Precise planning with flex insets

EN The lighting system can be easily adapted to existing room dimensions. Customised lengths can be specified for FRAME/MINO 40. The special flex insets are adapted precisely and flexibly on-site during installation: circuit boards are simply snapped off at premade breaking points: These are located at 62.5 mm or 125 mm, depending on the length of the profile. This gives you freedom and hardly any restrictions when planning the lighting.

DE Das Lichtsystem lässt sich einfach an vorhandene Raumdimensionen anpassen. Für FRAME/MINO 40 können individuelle Längen bestimmt werden. Die speziellen Flex-Insets werden vor Ort bei der Montage exakt und flexibel angepasst: Platinen werden einfach an vorgefertigten Bruchstellen abgetrennt. Diese befinden sich je nach Länge des Profils bei 62,5 mm oder 125 mm. Dadurch haben Sie freie Hand und kaum Einschränkungen bei der Lichtplanung.



Continuous cover

EN The flexibly adjustable continuous cover can be adapted to the respective profile length on-site, as required. This creates a continuous lighting system without any disruptive joints.

DE Das flexibel kürzbare Continuous Cover kann nach Bedarf vor Ort auf die jeweilige Profillänge angepasst werden. Dadurch entsteht ein durchgängiges Lichtsystem ohne störende Stoßstellen.

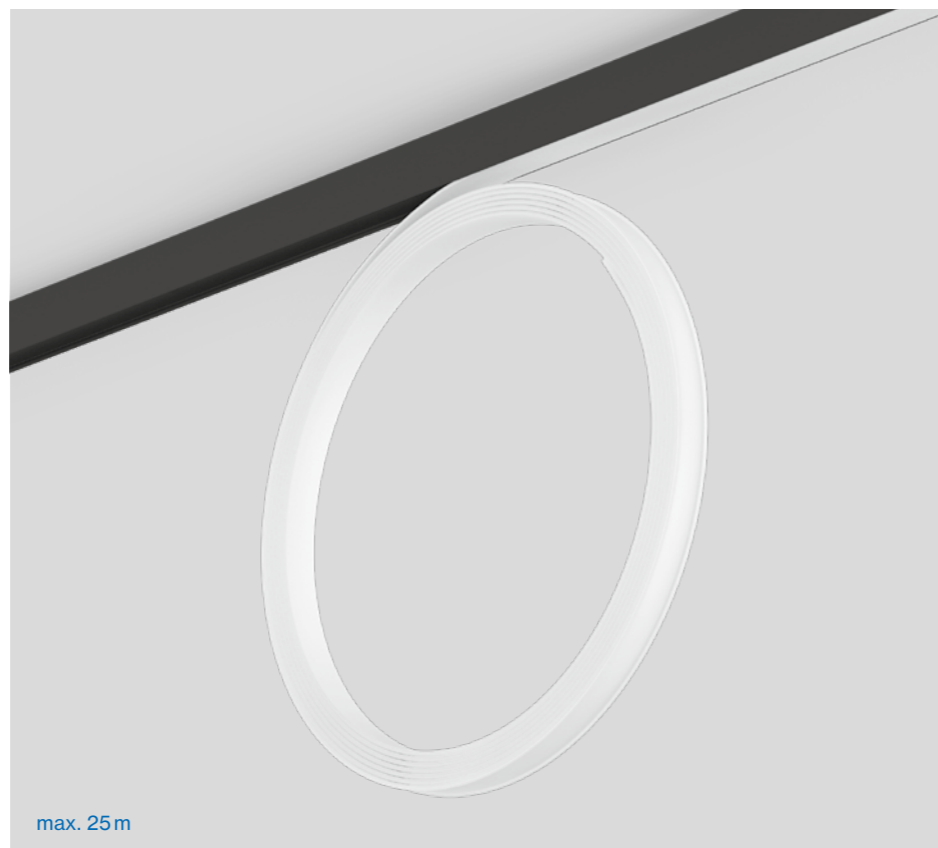

Reflector inset

EN The reflector inset, specially developed for the workplace, can be unlocked via buttons on the inset and thus inserted into the track without tools thanks to a patented mechanism, or individual insets can be strung together.

DE Das speziell für den Arbeitsplatz entwickelte Reflektor-Inset kann über Taster am Inset entriegelt und damit werkzeuglos in die Stromschiene dank eines patentierten Mechanismus eingesetzt oder einzelne Insets aneinandergereiht werden.

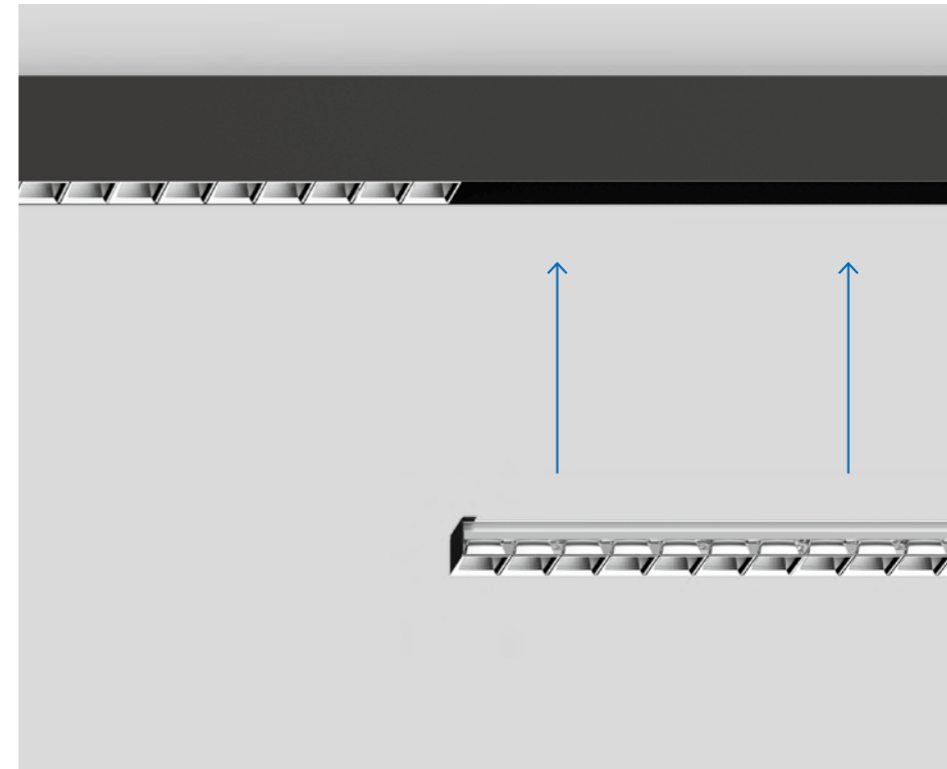

unlock inset via button

Spotlight and wallwasher inset

EN The one lamp and two lamps BO inset provides stylish wall, floor, and ceiling accent lighting. The SASSO wallwasher floor light inset is also perfect for uniform wall illumination. The insets can be unlocked via buttons and thus easily repositioned in the track.

DE Das ein- und zweiflämmige BO-Inset sorgt für eine stilvolle Wand-, Boden- und Deckenakzentuierung. Zudem eignet sich der SASSO Wallwasher Floor Lichteinsatz perfekt für eine gleichmäßige Wandausleuchtung. Die Insets können über Taster entriegelt und damit unkompliziert in der Stromschiene neu platziert werden.

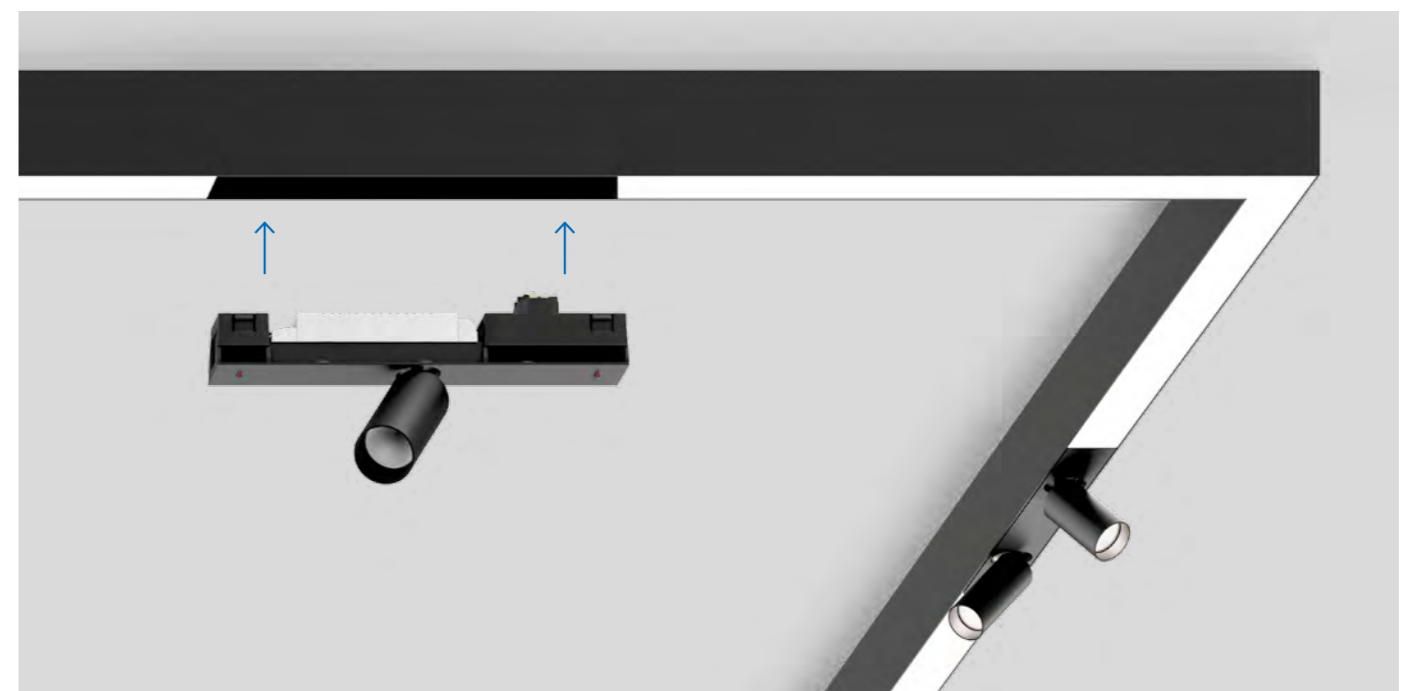

← back

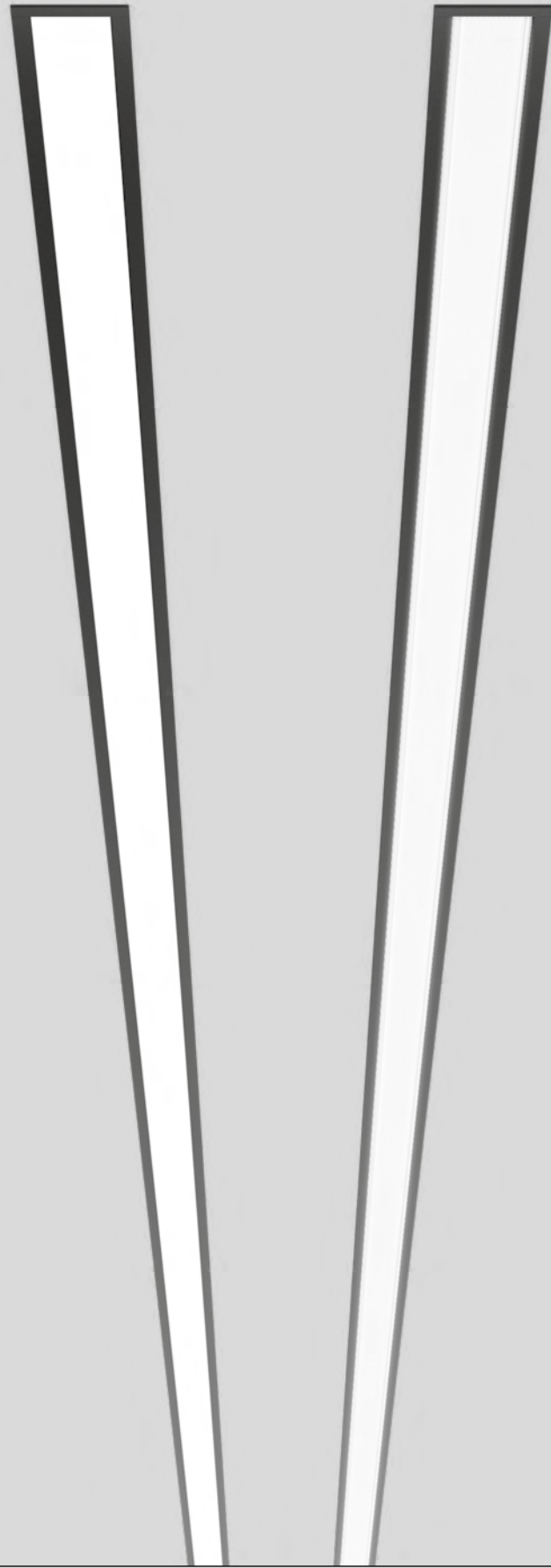

FRAME 40 system
opal/micropismatic

recessed with trim

Quickinfo

3000K, 4000K
CRI ≥ 90, 3 SDCM
up to 125lm/W
up to 2240lm/m
L90@50000h
DALI-2
opal, micropismatic

Types

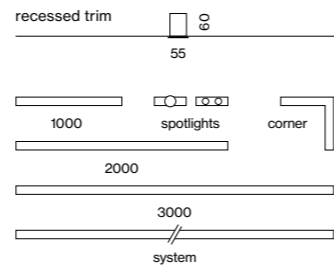

Colours



Light distributions



opal microp.



Data Monitoring
DiiA® standards 251, 252, 253



snap-in system (patent pending)



spotlight insets (p.90)



breakable flex insets



Staatsarchiv und Kantonsbibliothek Uri, CH –
by hts architekten + partner ag with lighting design
by Lichtblick, Lichtplanung und Lichtdesign AG



FRAME 40 system reflector

recessed with trim

Quickinfo

3000K, 4000K
CRI ≥ 90, 3 SDCM
UGR ≤ 19 / 65° ≤ 1500 cd/m²
up to 122lm/W
up to 3220lm/m
L90@50000h
DALI-2
reflector (UGR ≤ 19)

Types

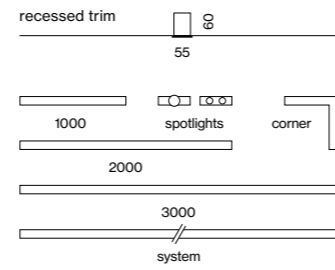

Colours



Light distribution

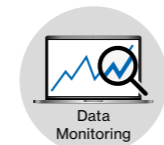

DiiA® standards
251, 252, 253



DIN EN 12464-1
UGR ≤ 19



snap-in system
(patent pending)



spotlight
insets (p.90)



Held & Francke Hinzenbach, AT –
by Architekturbüro Arkade Haslach

← back

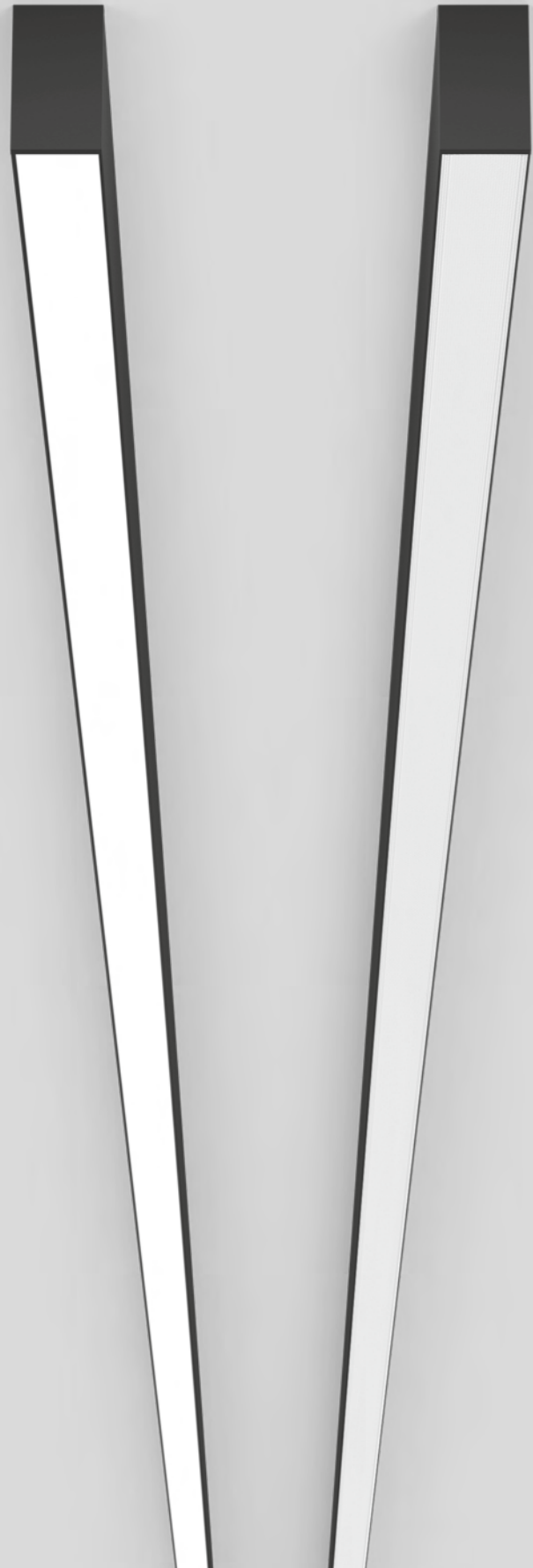

MINO 40 system
opal/micropismatic

ceiling/suspended

Quickinfo

3000K, 4000K
 CRI ≥ 90, 3 SDCM
 up to 125lm/W
 up to 2240lm/m
 L90@50000h
 DALI-2
 opal, micropismatic

Types

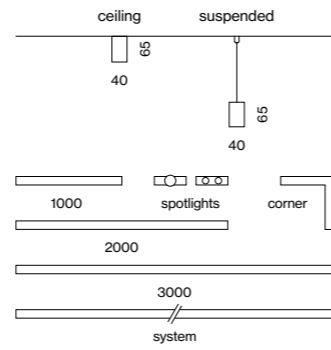

Colours



Light distributions

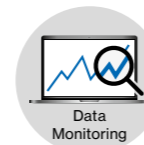
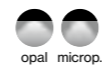

Data Monitoring
DiiA® standards 251, 252, 253



snap-in system (patent pending)



spotlight insets (p.90)



breakable flex insets

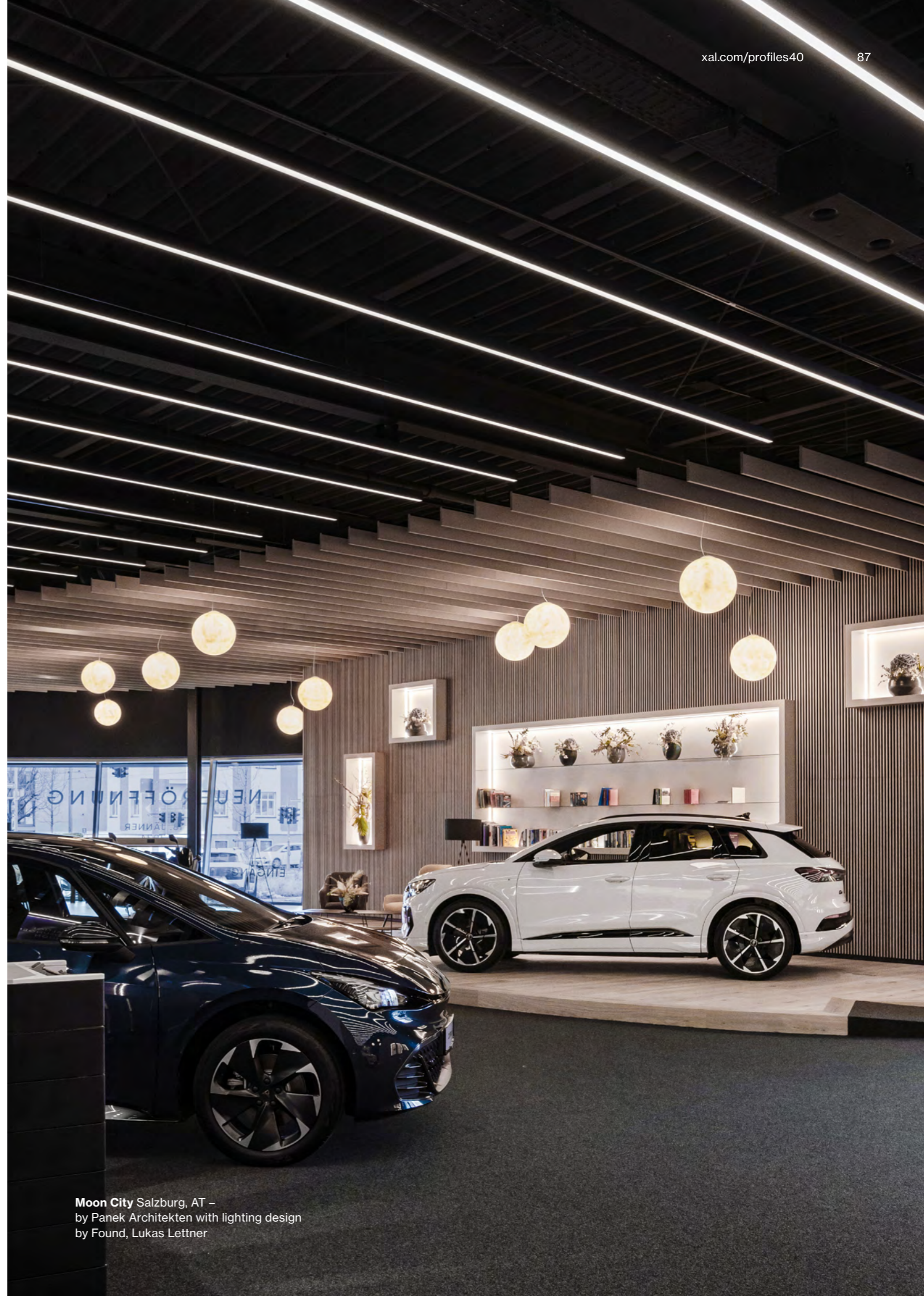

Moon City Salzburg, AT –
 by Panek Architekten with lighting design
 by Found, Lukas Lettner



MINO 40 system reflector

ceiling / suspended

Quickinfo

3000K, 4000K
 CRI ≥ 90 , 3 SDCM
 UGR ≤ 19 / $65^\circ \leq 1500 \text{ cd/m}^2$
 up to 122lm/W
 up to 3220lm/m
 L90@50000h
 DALI-2
 reflector (UGR ≤ 19)

Types

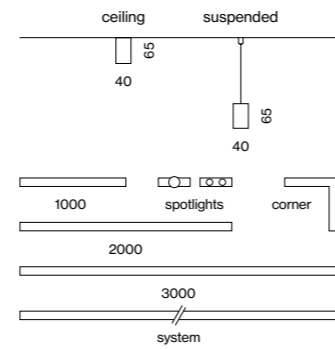

Colours

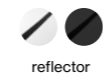

Light distribution



DiiA® standards
251, 252, 253



REV'IT! Sport International Oss, NL –
 by Cepezed Architects with lighting design
 by Nadja Smits of Eikelenboom

← back



SPOTLIGHT insets

profiles 40

Quickinfo

3000K, 4000K
 CRI ≥ 90, 2 SDCM
 BO 32 up to 79lm/W
 BO 45 up to 84lm/W
 SASSO 40 up to 83lm/W
 L80@50 000h
 DALI-2

Types

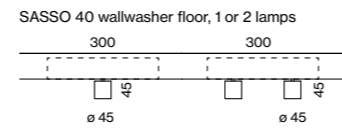
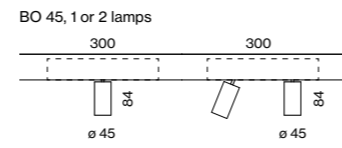
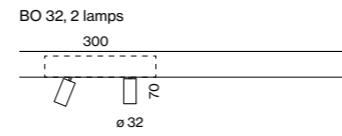

Colours



Light distributions



snap-in system (patent pending)



optical accessories



wallwasher floor 360° rotatable



wallwasher floor



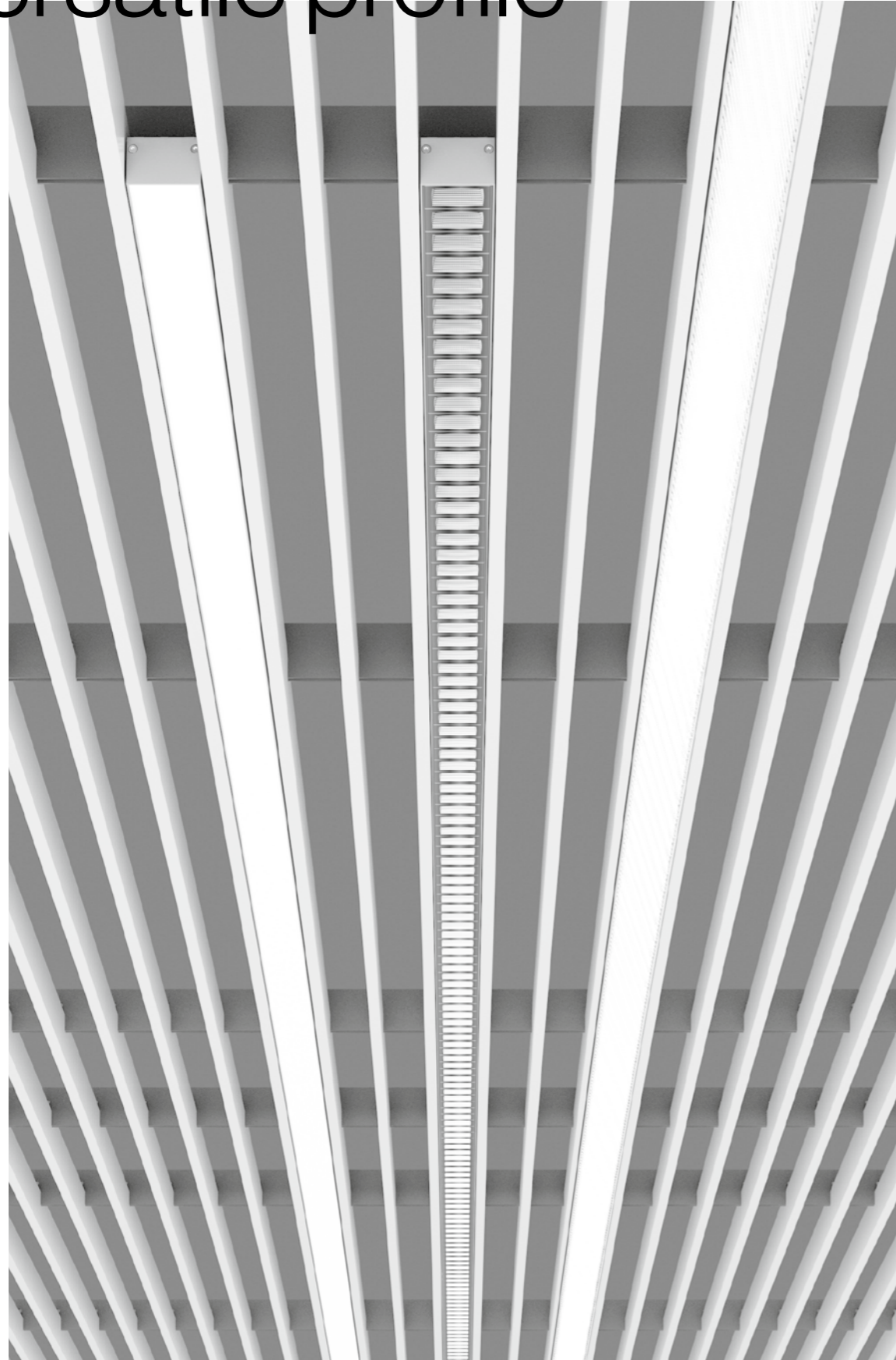

Versatile profile



MILA system

EN The MILA system luminaire was specially designed for use in slatted ceilings and blends seamlessly into the respective room design in entrance halls and office buildings. In meeting rooms and offices, the luminaire creates ideal screen-compatible working light thanks to the optional reflectors. In the opal and microprismatic variant, MILA guarantees homogeneous room illumination. The flexibly adjustable continuous cover is the best choice for continuous seamless lighting systems. By adding special sensors, the MILA system luminaire also becomes a smart lighting system.

DE Die MILA Systemleuchte wurde speziell für den Einsatz von Lamellendecken konzipiert und fügt sich in Eingangshallen sowie Bürogebäuden nahtlos in das jeweilige Raumkonzept ein. In Meetingräumen und Büros schafft die Reflektor-Variante ein ideales bildschirmtaugliches Arbeitslicht. In der opalen und microprismatischen Variante eignet sich MILA für eine homogene Raumausleuchtung. Für durchgängige stoßfreie Lichtsysteme ist das flexibel kürzbare Continuous Cover die beste Wahl. Durch die Erweiterung mit speziellen Sensoren wird die MILA Systemleuchte zusätzlich zum smarten Beleuchtungssystem.

Type	
	38
Mounting	
	ceiling
Configuration	
	linear
Light distributions	
	opal micro-prismatic reflector (UGR ≤ 19) direct

Inset variety

EN Whether workplace or general lighting – the MILA system luminaire can be adjusted depending on the area of application. The glare-free reflectors are the right choice for screen-compatible task lighting, while the opal and microprismatic cover is suitable for homogeneous ambient lighting.

DE Ob Arbeitsplatz- oder Allgemeinbeleuchtung – die MILA Systemleuchte lässt sich je nach Einsatzgebiet variieren. Für die bildschirmtaugliche Arbeitsplatzbeleuchtung sind die entblendeten Reflektoren die richtige Wahl, während das opal und mikroprismatische Cover für eine homogene Grundausleuchtung geeignet ist.

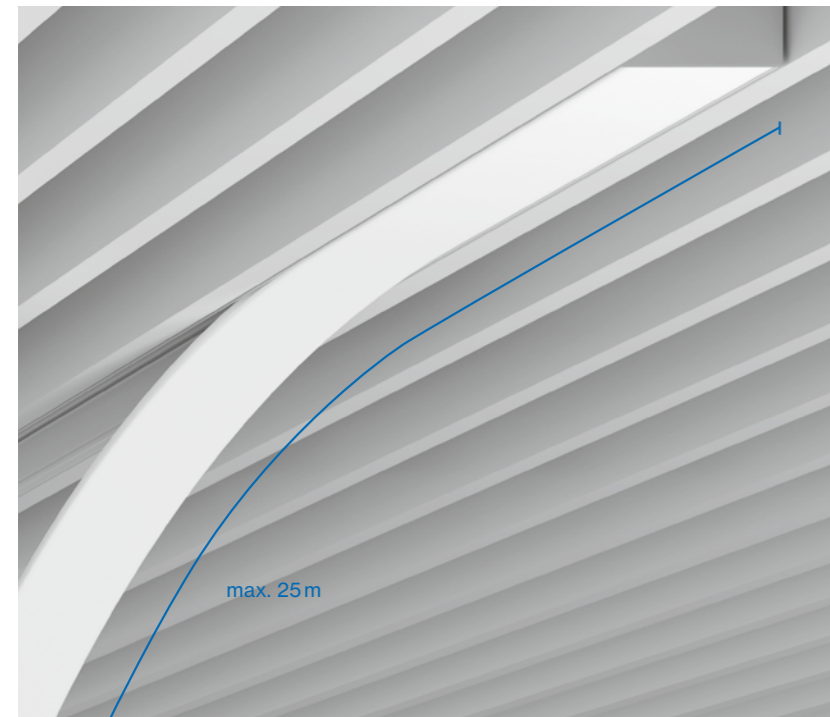
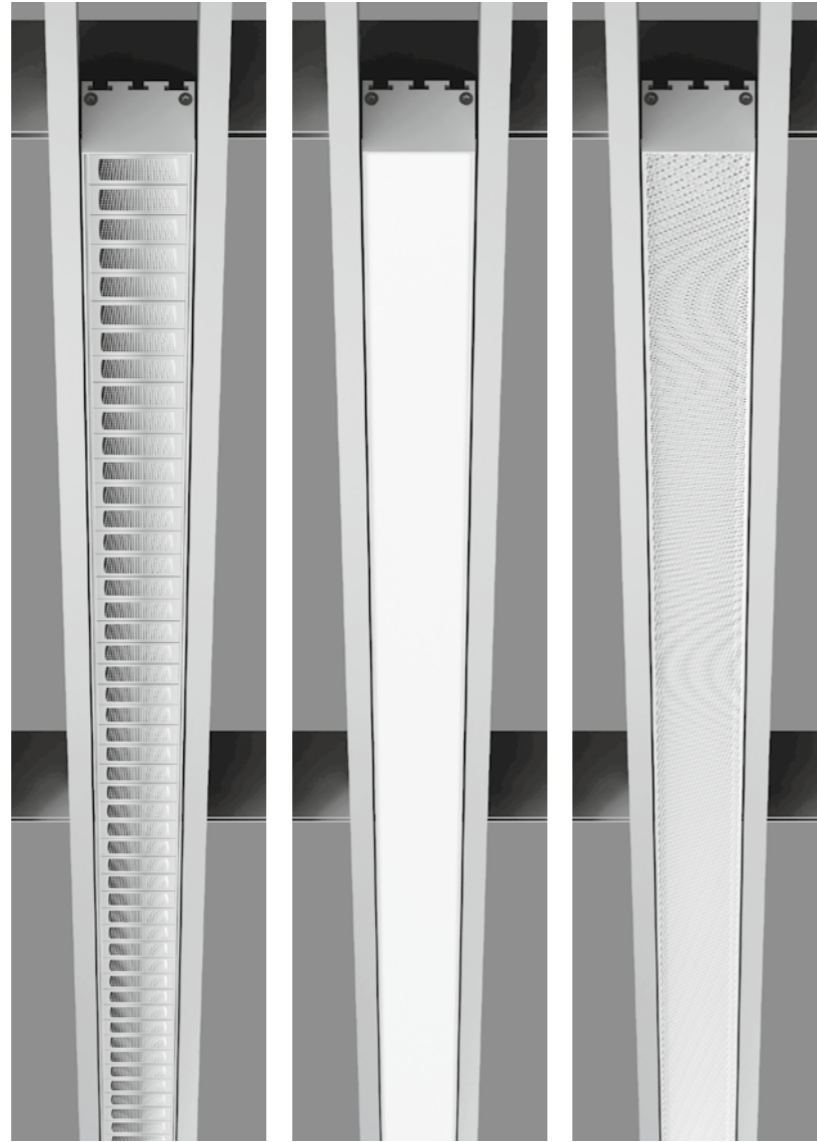

Continuous cover

EN Both the opal and the microprismatic cover are available as a continuous version for MILA system luminaires. The flexibly adjustable Continuous Cover can be adapted to the respective profile length on site and simply integrated into the profile during installation. This creates a continuous lighting system without any annoying joints.

DE Sowohl das opale als auch das mikroprismatische Cover stehen für die MILA Systemleuchten als Continuous Version zur Verfügung. Das flexibel kürzbare Continuous Cover kann nach Bedarf vor Ort auf die jeweilige Profillänge angepasst und bei der Montage einfach in das Profil integriert werden. Dadurch entsteht ein durchgängiges Lichtsystem ohne störende Stoßstellen.

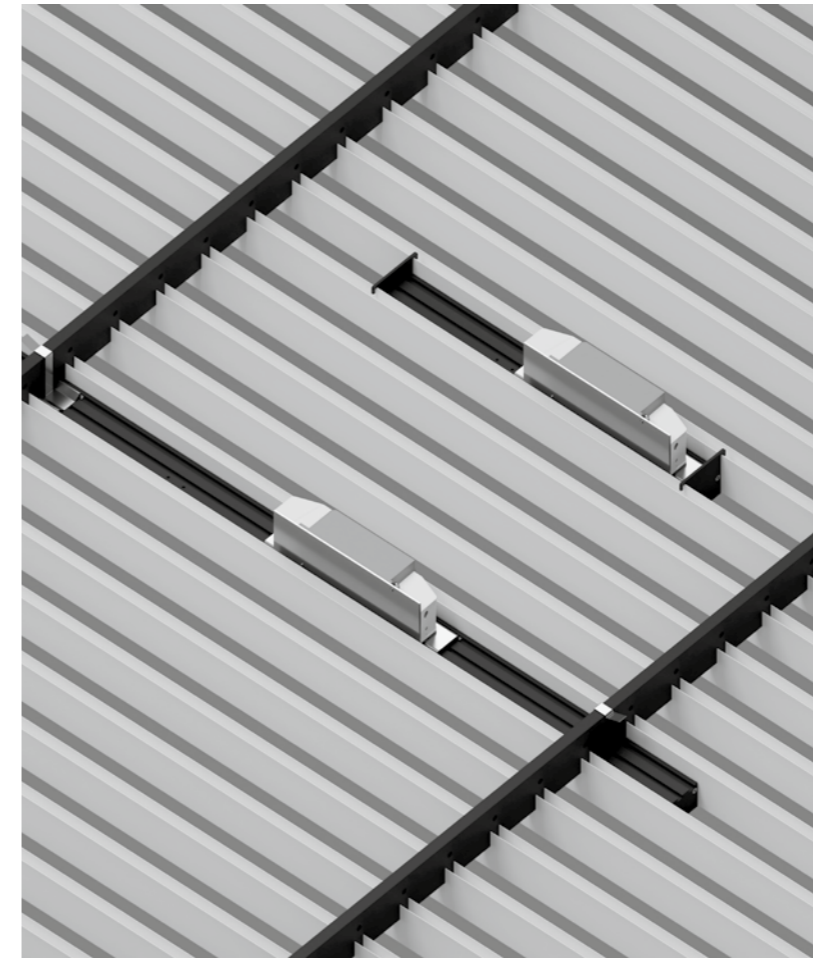

Mounting

EN MILA can provide the right lighting in any room using sturdy mounting brackets that are attached to the slatted ceiling. The brackets and the converter can be moved flexibly along the luminaire and can therefore be positioned as required or be subsequently adapted. Converters with through wiring make electrical installation easier, as wiring can be carried out quickly and easily from luminaire to luminaire. In addition, the converter can be moved freely, allowing a flexible response to the ceiling conditions.

DE Über stabile Befestigungsklammern, welche an der Lamellendecke eingehängt werden, kann MILA in jedem Raum für die passende Beleuchtung sorgen. Die Klammern und der Converter sind entlang der Leuchte flexibel verschiebbar und können so bedarfsorientiert platziert oder nachträglich angepasst werden. Converter mit Through-Wiring-Funktion erleichtern die elektrische Montage, da die Verdrahtung einfach und schnell von Leuchte zu Leuchte durchgeführt werden kann. Außerdem kann durch die freie Verschiebbarkeit des Converters flexibel auf die Deckengegebenheiten reagiert werden.

Advanced sensor technology

EN By adding special sensors, the MILA system luminaire becomes a smart lighting system. The sensors can be positioned freely and flexibly in the slatted ceiling and can also be integrated quickly and easily later. Using the ESSENTIAL sensor, the lighting adapts dynamically to the ambient brightness and room activity. The SENSE sensor also measures temperature, air quality, humidity, and noise levels. This data provides important information about the ambient conditions and supports long-term energy savings.

DE Durch die Erweiterung mit speziellen Sensoren wird die MILA Systemleuchte zum smarten Beleuchtungssystem. Die Sensoren können in der Lamellendecke frei und flexibel platziert werden und auch nachträglich schnell und einfach integriert werden. Mittels ESSENTIAL-Sensor passt sich die Beleuchtung dynamisch an die Umgebungshelligkeit und Raumaktivität an. Mit dem SENSE-Sensor werden ergänzend Werte zu Temperatur, Luftqualität, Luftfeuchtigkeit und Geräuschpegel gemessen. Diese Daten liefern nicht nur wichtige Erkenntnisse über die Umgebungsbedingungen, sondern unterstützen langfristig Energieeinsparungen.

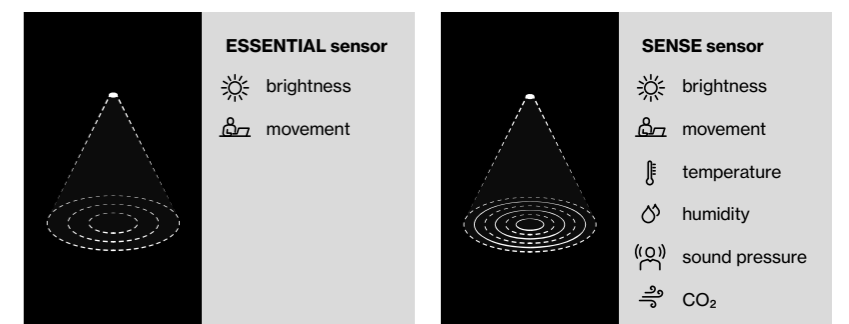

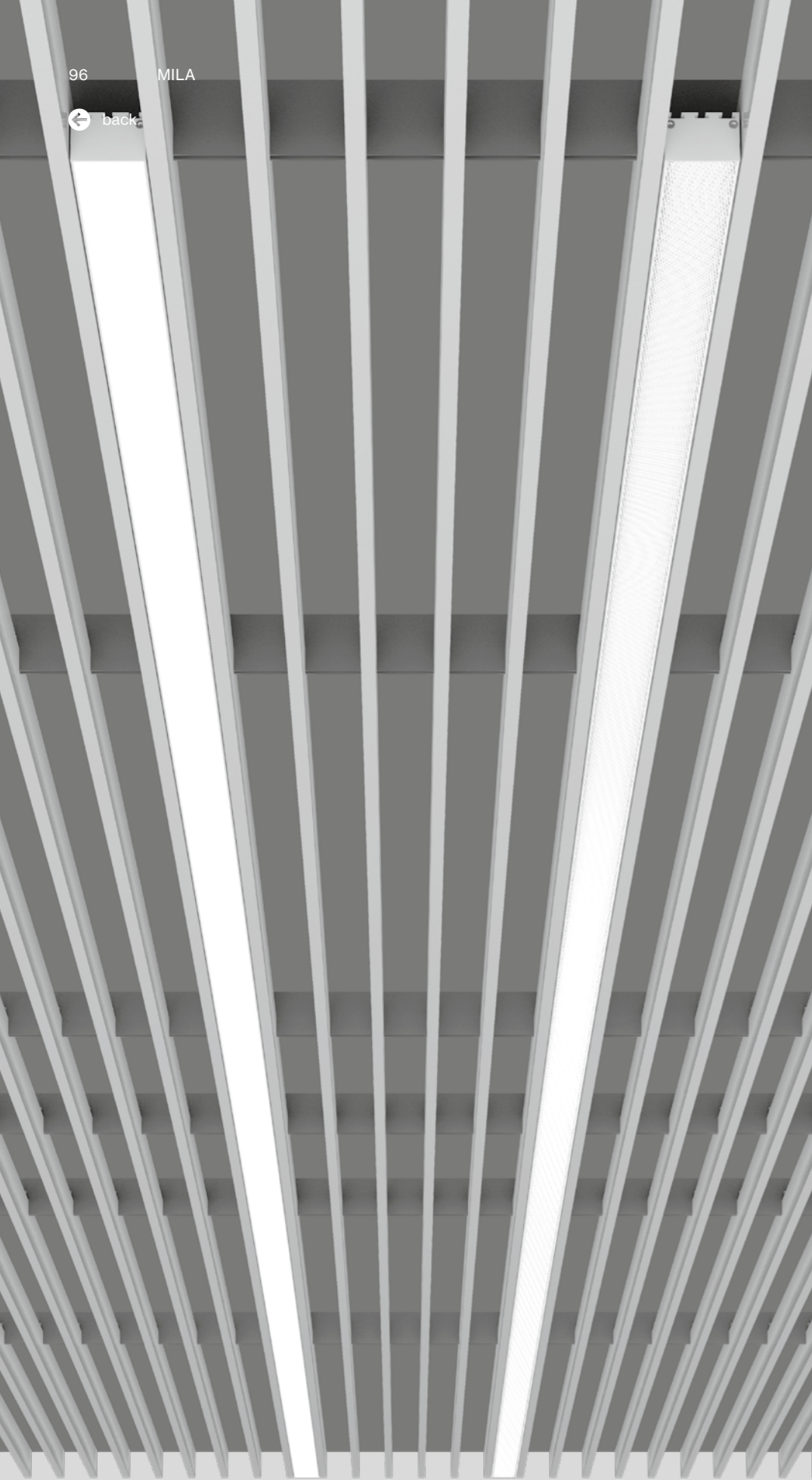

MILA system
opal/microprismatic
ceiling

Quickinfo

3000K, 4000K
CRI ≥ 90, 3 SDCM
up to 109lm/W
up to 2450lm/m
L90@50 000h
DALI-2
opal, microprismatic

Types

opal/microprismatic

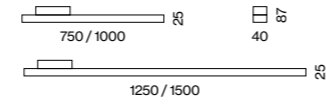

Colours



Light distributions



suitable for
HAUFE ceilings

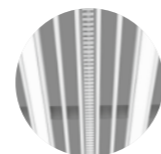

continuous
lighting system



sensor for
single mounting



up to 109lm/W
(high efficiency)



Viega GmbH Attersee, AT –
by ATP Planungs- und Beteiligungs AG with
lighting design by Andreas Haidegger

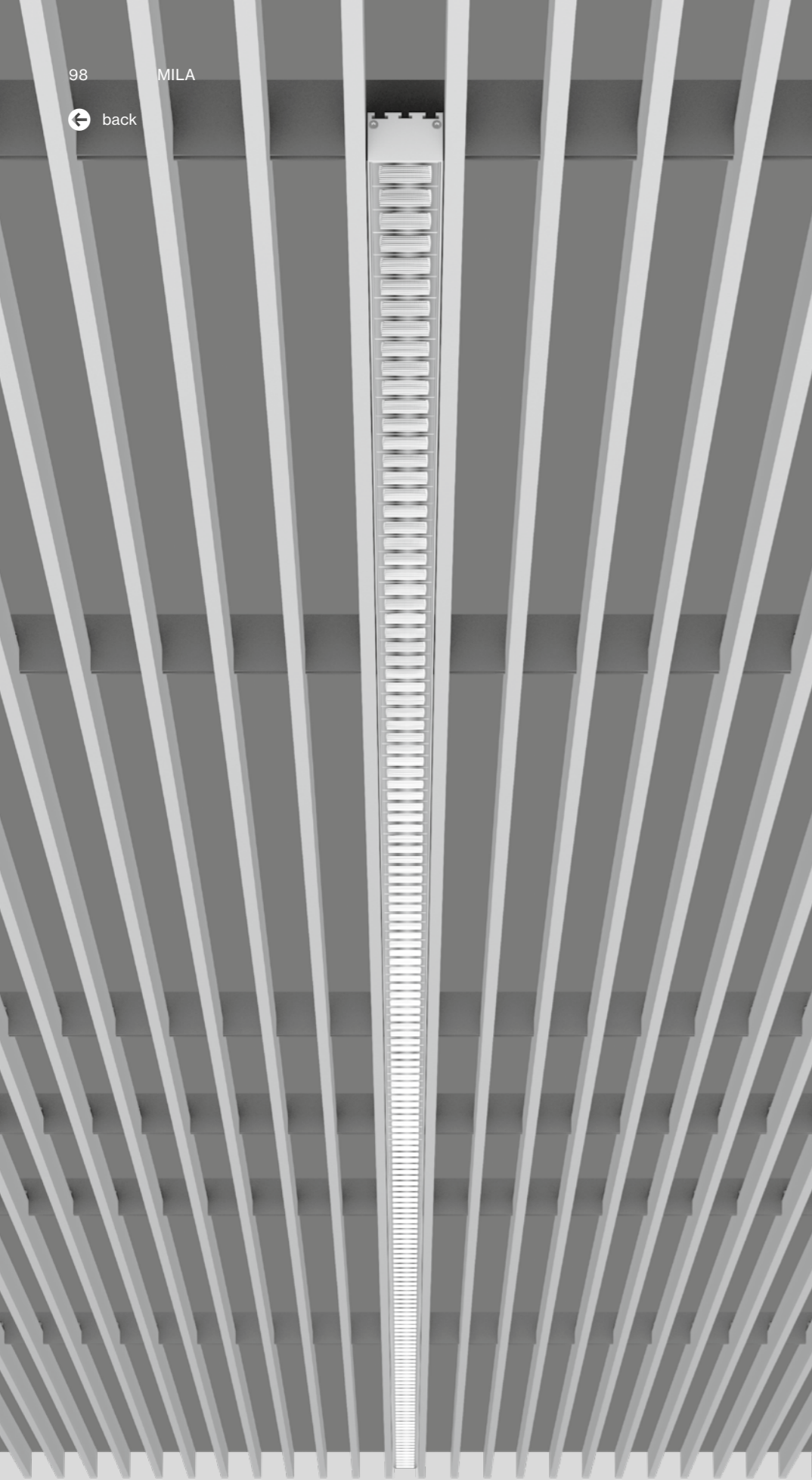

MILA system reflector
ceiling

Quickinfo

3000K, 4000K
CRI ≥ 90, 3 SDCM
UGR ≤ 19 / 65° ≤ 1500 cd/m²
up to 122 lm/W
up to 3280 lm/m
L90 @ 50 000h
DALI-2
reflector (UGR ≤ 19)

Types

reflector

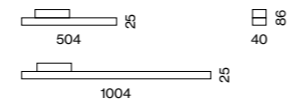

Colours



Light distribution



suitable for
HAUFE ceilings

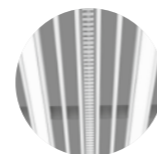

continuous
lighting system



DIN EN 12464-1
UGR ≤ 19



up to 122 lm/W
(high efficiency)



Viega GmbH Attersee, AT –
by ATP Planungs- und Beteiligungs AG with
lighting design by Andreas Haidegger

Flexible lighting for well-being



VITA

EN As a modular lighting system that fulfils the particular requirements of the hospital and care sector, VITA MED also offers planning freedom in the design of patient rooms. The combined indirect/direct modules create an agreeable ambient effect extending from the bed and can also be used as reading and examination lighting. The indirect component provides pleasant ceiling illumination. The light insets can be controlled separately, allowing the room light and the reading and examination light to be individually combined. The light can also be used as a night light thanks to the dimming function and predefined light programmes can be called up. This results in improved working conditions for doctors and carers, while patients receive the ideal light intensity for good vital functions and a positive melanopic effect.

DE Als modulares Lichtsystem, welches die hohen Anforderungen im Kranken- und Pflegebereich erfüllt, bietet VITA MED zugleich planerische Freiheit in der Gestaltung von PatientInnenzimmern. Die kombinierten Indirekt/Direkt-Module ermöglichen ausgehend vom Bett eine angenehme Raumwirkung sowie den zielgenauen Einsatz als Lese- und Untersuchungslicht. Der Indirektanteil sorgt für eine angenehme Deckenaufhellung. Die Lichteinsätze sind getrennt steuerbar, wodurch sich Raumlicht und Lese- und Untersuchungslicht individuell kombinieren lassen. Die Leuchte kann durch die Dimmfunktion auch als Nachtlcht verwendet werden sowie vorab definierte Lichtprogramme abrufen. Für ÄrztInnen und PflegerInnen ergeben sich verbesserte Arbeitsbedingungen, während die PatientInnen die optimale Lichtintensität für eine ausgeprägte Vitalfunktion und eine positive melanopische Wirkung erhalten.

Module insets

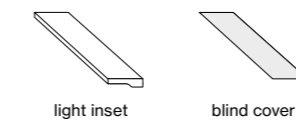

Modules

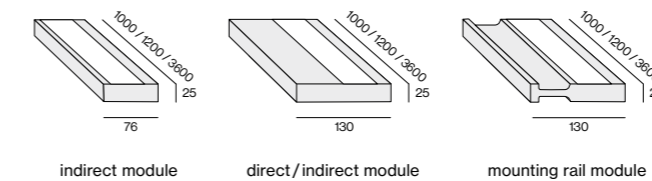

Supply duct

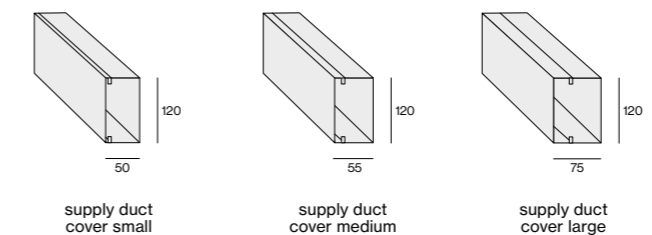

Light distributions

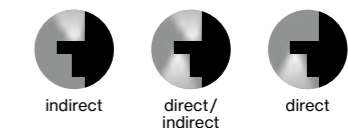

Colours



Mounting types

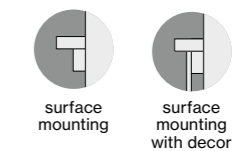

Regulatory standards & specifications

EN The products used by VITA MED comply with the basic performance requirements of Regulation (EU) 2017/745 of the European Parliament and of the European Council of 5 April 2017 on medical devices (MDR). VITA MED is a modular supply unit for use in medical rooms and is manufactured strictly in accordance with the latest state of the art (EN ISO 11197:2019). The VITA MED light insets fulfil all the important requirements for patient room lighting. The modified value of 200 lx is achieved, as is the minimum illuminance value of 100 lx defined at floor level (see EN 12464-1:2021). The illuminance of 300 lx is complied with for both the reading lights and light for simple examinations. The modified values of 750 lx can be achieved by adding several indirect lighting insets. All light insets fall below the limit value of the standardised glare rating of $UGR \leq 19$, which means that VITA MED provides the best light for care staff and patients.

DE Die bei VITA MED zum Einsatz kommenden Produkte entsprechen den grundlegenden Leistungsanforderungen der Verordnung (EU) 2017/745 des europäischen Parlaments und des Rates vom 5. April 2017 über Medizinprodukte, kurz MDR. VITA MED ist eine modulare Versorgungseinheit für den Einsatz in medizinisch genutzten Räumen und wird strikt nach neuestem Stand der Technik gefertigt (EN ISO 11197:2019). Die Lichteinsätze von VITA MED erfüllen alle wichtigen Anforderungen hinsichtlich Beleuchtung im PatientInnenzimmer. Der modifizierte Wert von 200 lx wird ebenso erreicht wie der auf Bodenhöhe definierte Mindestwert der Beleuchtungsstärke von 100 lx (siehe EN 12464-1:2021). Beim Leselicht und dem Licht für einfache Untersuchungen wird die Beleuchtungsstärke von 300 lx eingehalten. Die modifizierten Werte von 750 lx können durch die Ergänzung von mehreren indirekt wirkenden Lichteinsätzen erreicht werden. Bei allen Lichteinsätzen wird der Grenzwert der vereinheitlichten Blendbewertung von $UGR \leq 19$ unterschritten, wodurch VITA MED bestes Licht für das Pflegepersonal sowie für die PatientInnen bietet.

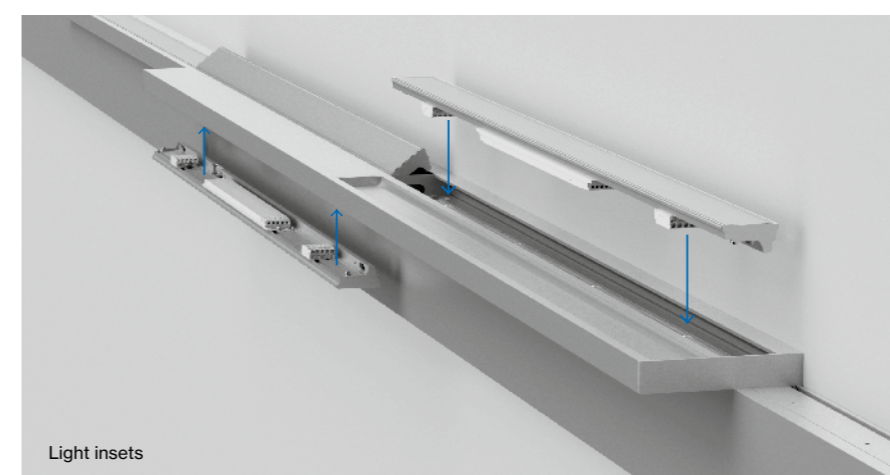
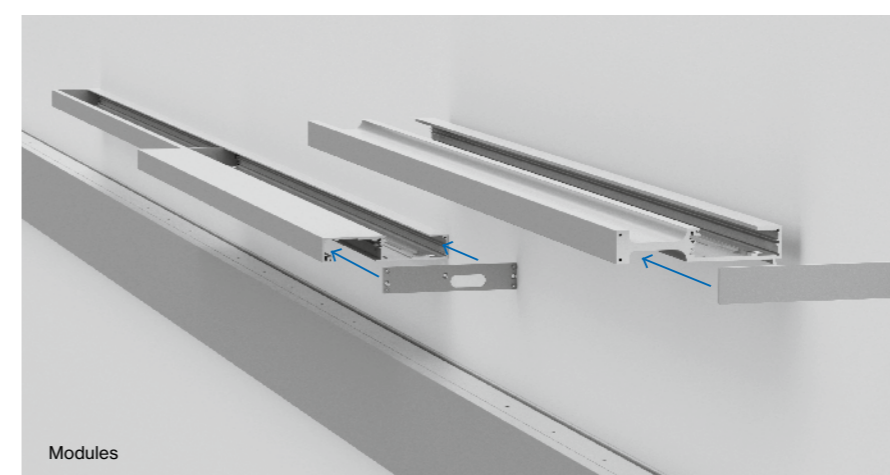
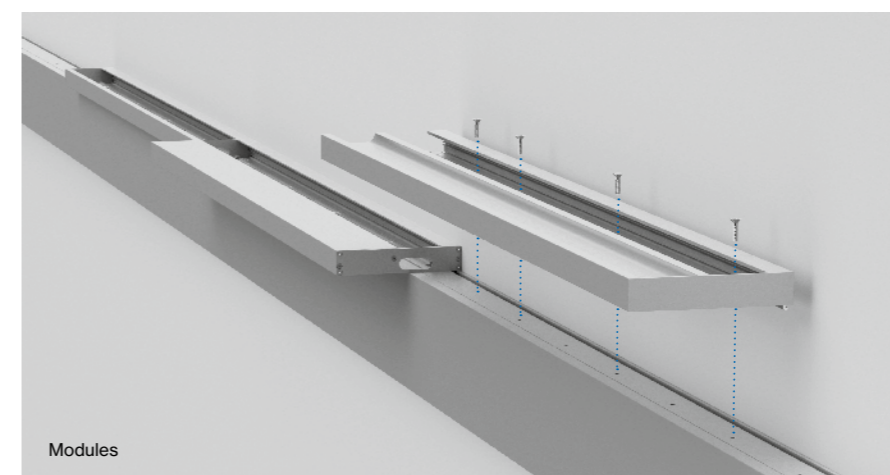
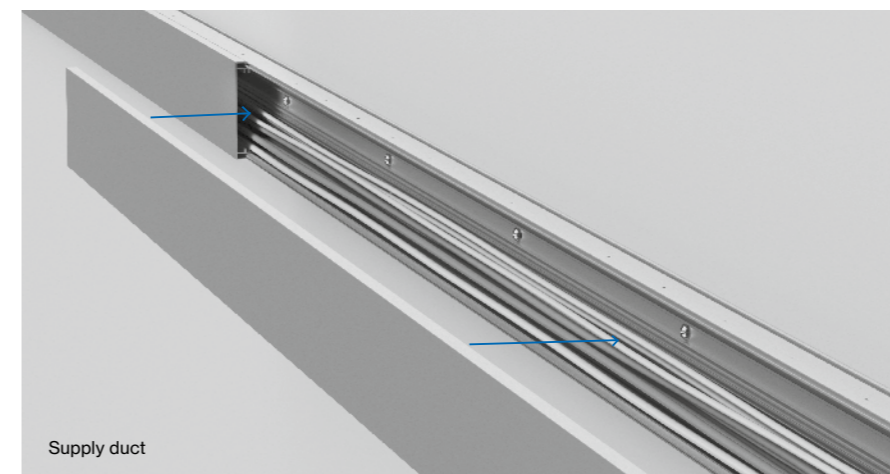

Flexible luminaire positioning

EN The VITA MED system is a modular lighting system that enables flexible, customisable lighting in the rooms. The modules, which are easy to install on the supply channel, can be repositioned or supplemented with additional lighting elements at any time. A blind cover can also be replaced by a light inset and vice versa. In this way, VITA MED enables the ideal room atmosphere to be created even when beds are moved or conditions change.

DE Das VITA MED System ist ein modulares Beleuchtungssystem, welches eine flexibel anpassbare Beleuchtung in den Zimmern ermöglicht. Die am Versorgungskanal leicht montierbaren Module können jederzeit neu positioniert oder mit weiteren Lichtelementen ergänzt werden. Auch kann ein Blindcover durch einen Lichteinsatz und vice versa ersetzt werden. So ermöglicht VITA MED auch bei Bettenverschiebungen oder sich ändernden Rahmenbedingungen die ideale Raumatmosfera.

Melanopic response

EN Light and light quality are key factors for health. The correct lighting creates an atmosphere that supports patient recovery and provides nursing staff with a positive work environment. Using cylindrical illuminance, the biological support effect is 371lx at 3000K and 299lx at 4000K. For those aged over 50, these values must be increased by 50%. VITA MED exceeds this requirement, both for patients and healthcare workers. VITA MED also meets the requirement for biological activation with 75-year-old users, even taking into account the age-specific correction factors in accordance with DIN T/S 5031-100.

DE Licht und Lichtqualität sind ein bedeutender Gesundheitsfaktor. Die richtige Beleuchtung schafft eine Atmosphäre, die gleichermaßen PatientInnen bei der Genesung unterstützt und dem Pflegepersonal ein aktivierendes Arbeitsumfeld bietet. Die biologisch unterstützende Wirkung mittels zylindrischer Beleuchtungsstärke liegt mit 3000K bei 371lx, bzw. mit 4000K bei 299lx. Für über 50-Jährige müssen diese Werte um 50% angehoben werden. VITA MED übererfüllt diese Anforderung – sowohl für PatientInnen als auch für das Gesundheitspersonal. Selbst bei Beachtung der altersspezifischen Korrekturfaktoren gemäß DIN T/S 5031-100 erfüllt VITA MED die Anforderung für eine biologische Aktivierung von 75-jährigen NutzerInnen.



Control light scenes

EN When using VITA MED, the combination of direct and indirect light insets creates the desired light intensity in the room. Thanks to the user-friendly, optionally available DALI control system, up to 16 lighting scenes can be saved and easily called up by staff via a touch panel. One possible variant would be the combination of reading light, examination light, and two supplementary dynamic indirect light scenes, which can be switched on and off using switching or dimming buttons. Up to eight additional lights can be dimmed or switched.

DE Beim Einsatz von VITA MED ergibt sich durch die Kombination von direkten und indirekten Lichteinsätzen die jeweils gewünschte Lichtintensität im Raum. Dank der nutzerfreundlichen, optional erhältlichen DALI-Steuerung können bis zu 16 Lichtszenen gespeichert und vom Personal einfach über ein Touchpanel abgerufen werden. Eine mögliche Variante wäre die Kombination von Leselicht, Untersuchungslicht und zwei ergänzende dynamische indirekten Lichtszenen, welche über Schalt- oder Dimm-Taster ein- und ausgeschaltet werden können. Bis zu acht zusätzliche Leuchten lassen sich dimmen bzw. schalten.



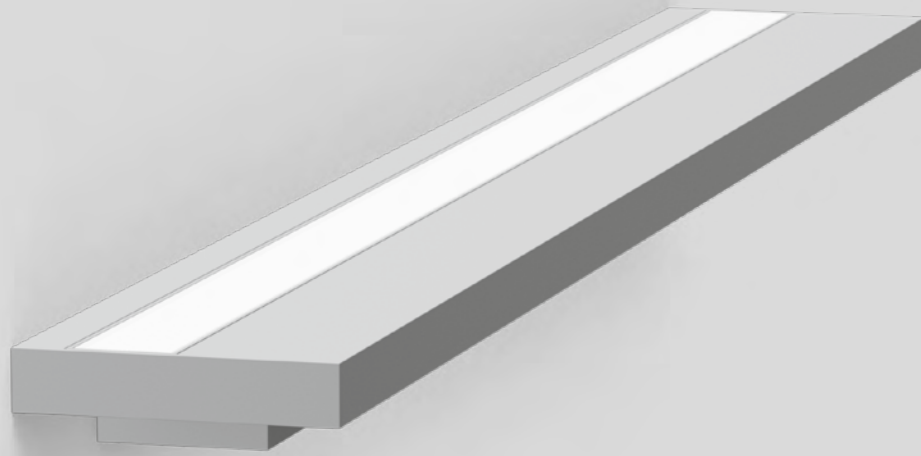

Quickinfo

3000K, 4000K
CRI ≥ 90, CRI ≥ 98 XPECTRUM
up to 121lm/W
up to 14760lm/m (direct + indirect)
L80/L85@50000h
DALI-2
reflector / linear prismatic

Types

horizontal mounting

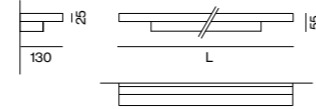

vertical mounting

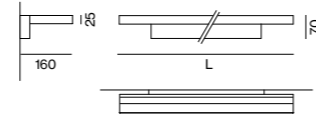

Colour



Light distributions

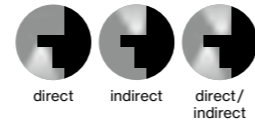

system solution



hygienic and easy to clean



outstanding colour fidelity

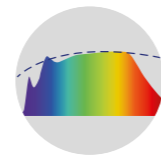

CRI ≥ 98 XPECTRUM



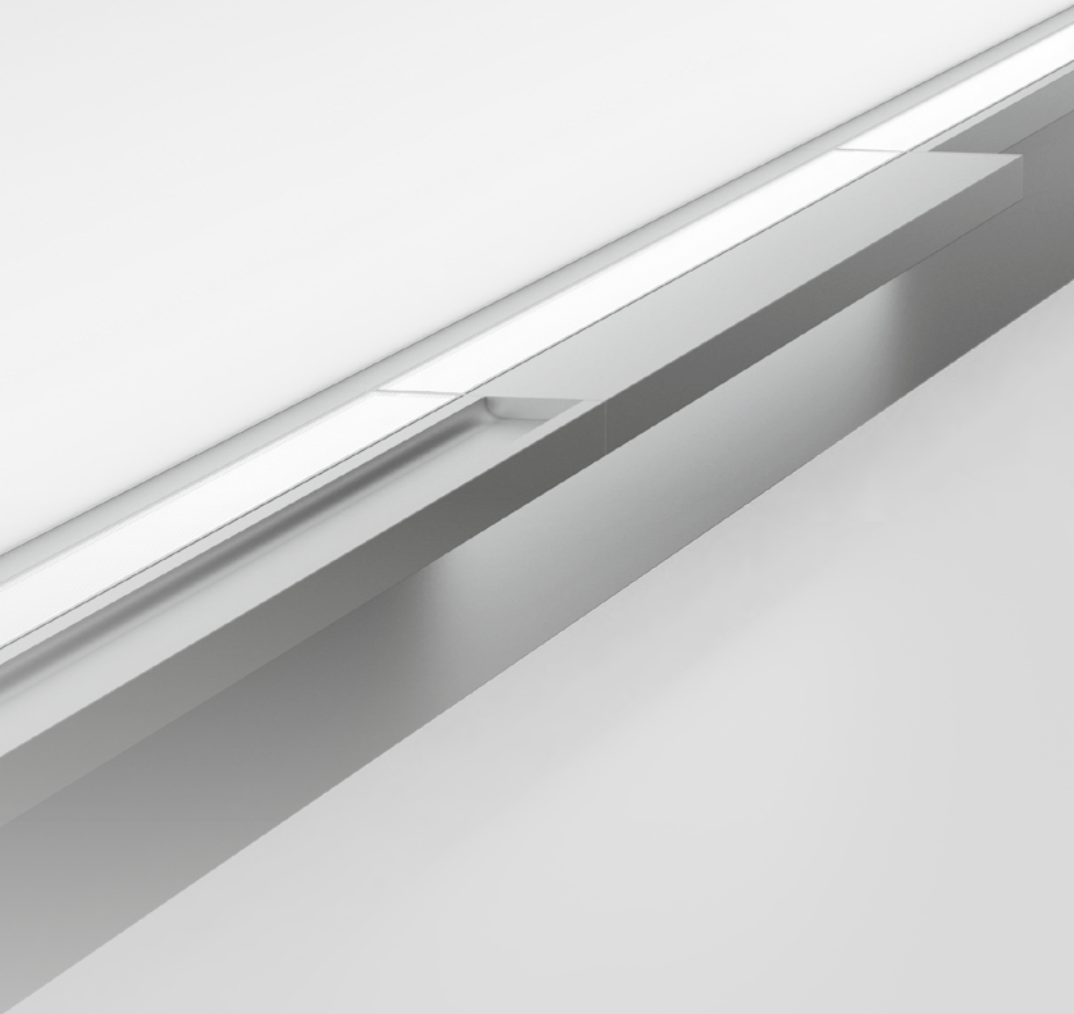

Quickinfo

3000K, 4000K
CRI ≥ 90, CRI ≥ 98 XPECTRUM
up to 115lm/W
up to 14790lm/m (direct + indirect)
L80/L85@50000h
DALI-2
reflector / linear prismatic

Types

direct | direct/indirect



indirect



Colours



Mountings

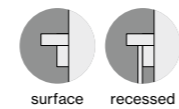

Light distributions

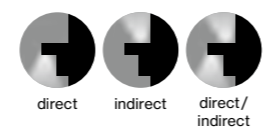

standard rails
MedGas



hygienic and
easy to clean



outstanding
colour fidelity

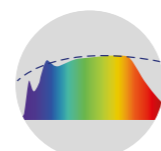

CRI ≥ 98
XPECTRUM



Intelligent light



Smart products with sensor technology

EN Modern lighting systems with daylight and motion sensors make it possible to optimise a room's quality and increase employee satisfaction and productivity. Thanks to smart-sensor technology, the luminaires react to movement and brightness, causing them to dim or switch off automatically. Data such as temperature, humidity, noise levels, and CO₂ content can also be measured using smart sensors. By evaluating relevant building data, you can precisely analyse building usage and optimise lighting. This in turn reduces your energy consumption while extending the luminaires' service life. Many XAL luminaires are already fitted with intelligent sensors to facilitate smart, energy-efficient control.

DE Optimierung der Raumqualität sowie die Steigerung der Zufriedenheit und Produktivität der Mitarbeiter: das ermöglichen moderne Beleuchtungssysteme mit Tageslicht- und Bewegungssensoren. Dank kluger Sensorik reagieren die Leuchten auf Bewegung und Helligkeit, wodurch sie sich automatisch dimmen oder ausschalten. Auch Daten wie Temperatur, Luftfeuchtigkeit, Geräuschpegel und CO₂-Gehalt können mit smarten Sensoren gemessen werden. Durch die Auswertung relevanter Gebäudedaten können Sie die Gebäude-nutzung genau analysieren und die Beleuchtung optimieren. Dies reduziert wiederum Ihren Energieverbrauch und verlängert gleichzeitig die Lebensdauer der Leuchten. Eine Vielzahl an XAL-Leuchten ist bereits mit intelligenten Sensoren ausgestattet und ermöglicht eine smarte, energieeffiziente Steuerung.

Types



sensor
essential



sensor
sense

← back

Overview

ESSENTIAL sensor

EN The ESSENTIAL sensor facilitates dynamic adjustment of the lighting to the ambient brightness and room activity. The sensor controls the luminaires via DALI. This established control mechanism helps you save energy with a smart lighting solution.

DE Der ESSENTIAL-Sensor ermöglicht die dynamische Anpassung der Beleuchtung an Umgebungshelligkeit und Raumaktivität. Der Sensor steuert die Leuchten über DALI. Dieser gängige Steuerungsmechanismus hilft Ihnen, mit einer smarten Beleuchtungslösung Energie zu sparen.

SENSE sensor

EN The SENSE sensor also measures values such as temperature, air quality, humidity, and noise level. This data not only provides important insights into the ambient conditions and utilisation of rooms, but also supports long-term energy savings. The SENSE sensor is IoT ready and facilitates data transmission via Wireless or DALI.

DE Die SENSE-Sensoren messen zusätzlich Werte wie Temperatur, Luftqualität, Luftfeuchtigkeit und Geräuschpegel. Diese Daten liefern nicht nur wichtige Erkenntnisse über die Umgebungsbedingungen und Nutzung von Räumen, sondern unterstützen langfristig Energieeinsparungen. Der SENSE Sensor ist IoT ready und ermöglicht die Datenübertragung mittels Wireless oder DALI.

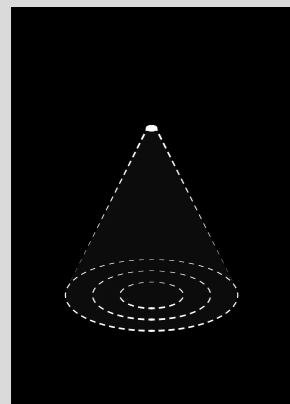

ESSENTIAL sensor

- brightness
- movement

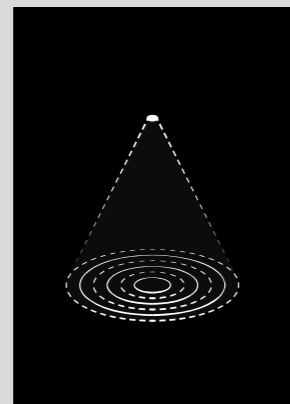

SENSE sensor

- brightness
- movement
- temperature
- humidity
- sound pressure
- CO₂

Stand-alone products

EN The stand-alone versions of UNICO, SASSO and MILA guarantee a standardised lighting concept with sensor technology. The sensors can be inserted into the housings like light insets. This means nothing stands in the way of subsequent sensor expansion.

DE Mit den Stand-Alone Varianten von UNICO, SASSO, und MILA ist ein einheitliches Beleuchtungskonzept mit Sensorik gewährleistet. Die Sensoren können wie Licht-Insets in die Housings eingesetzt werden. So steht einer nachträglichen Erweiterung mit Sensorik nichts im Wege.





UNICO Q1
recessed





SASSO 60 round
recessed

MILA system
ceiling

Smart luminaires

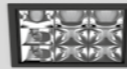
EN XAL products equipped with smart sensors enable a uniform lighting concept. With ESSENTIAL or SENSE sensors, important building data can be analysed and the lighting can be efficiently adapted to room activity and the rooms' natural brightness.

DE XAL-Produkte, die mit smarter Sensorik ausgestattet sind, ermöglichen ein einheitliches Beleuchtungskonzept. Mit ESSENTIAL- oder SENSE-Sensoren können wichtige Gebäudedaten analysiert und die Beleuchtung effizient an Raumaktivität sowie die natürliche Helligkeit der Räume angepasst werden.







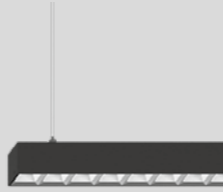

UNICO pro
recessed

UNICO Q1/Q4 basic
recessed

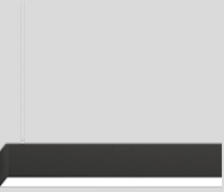
MITA circle 160
recessed

SONIC
suspended











BETO
suspended

SETA
suspended

LITO 60
suspended

TASK S
suspended



TASK
free standing

TASK square
free standing

TASK table

SONIC
free standing

BETO
free standing

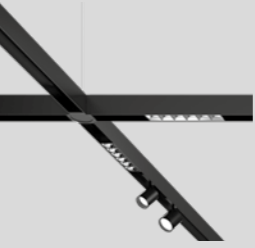
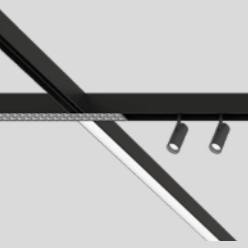
SETA system
ceiling/suspended

MOVE IT 25 system
recessed/surface/suspended

MOVE IT 45 system
recessed/surface/suspended

MOVE IT PRO system
recessed/surface/suspended

Get in contact

^{EN} We develop and perfect projects in dialogue with the architects and planners to make them unique. We see ourselves as your partner. From lighting design, the right product selection and control system to commissioning and maintenance, we are at your side throughout your project. Let's talk about your project: office@xal.com

^{DE} Wir haben es uns zu unserer Aufgabe gemacht, gemeinsam mit den ArchitektInnen und PlanerInnen die Projekte im Dialog zu entwickeln, zu perfektionieren und sie einzigartig zu machen. Wir sehen uns als Ihr Partner. Von der Lichtplanung über die richtige Produktauswahl und von der Steuerung bis hin zur Inbetriebnahme und Wartung stehen wir Ihnen in allen Phasen Ihres Projektes zur Seite. Reden wir über Ihr Projekt: office@xal.com

XAL Headquarters

XAL GmbH
Auer-Welsbach-Gasse 36
8055 Graz
AUSTRIA
T +43.316.3170
office@xal.com

All locations:
xal.com/contacts

List of photographers

Linus Lintner (Cover | p. 7–13), Philip Kottlorz (p. 15–19), Paul Ott (p. 21–25), HGEsch (p. 27–31), Kurt Kuball (p. 55 | 97 | 99 | 108 | 110), Porsche Vietnam (p. 57), sguarda fotografie (p. 61), Valentin Luthiger (p. 83), Wahl Architekturfotografie, Julia Wahl (p. 85), Catherine Roider (p. 87), Kris Dekeijser (p. 89)

Visualisations

^{EN} To inspire you with project images showing our latest product innovations, we have taken the liberty of editing existing project images or creating new visualisations.

Such edited or newly created images are labelled with the symbol 

^{DE} Um Sie mit Projektbildern, in denen unsere neuesten Produktinnovationen ersichtlich sind, zu inspirieren, haben wir uns die Freiheit genommen, vorhandene Projektbilder zu bearbeiten oder neue Visualisierungen zu erstellen.

Solche bearbeiteten oder neu erstellten Bilder sind durch das Symbol  gekennzeichnet.

Legal notices

^{EN} Information in this catalogue was valid at the time of printing, is non-binding, and should be used for information purposes only. We are not liable for products that differ from illustrations or information. We reserve the right to make changes to our products at any time. All orders will be accepted exclusively in accordance with our general terms and conditions of business and delivery. The latest version of these terms and conditions is available at www.xal.com.

^{DE} Die Angaben in diesem Katalog entsprechen dem Stand bei Drucklegung, sind unverbindlich und sollen ausschließlich Informationszwecken dienen. Für Abweichungen eines Produkts von Abbildungen oder Angaben wird keine Haftung übernommen. Wir behalten uns vor, jederzeit Änderungen an unseren Produkten vorzunehmen. Alle Aufträge werden ausschließlich zu unseren Allgemeinen Geschäfts- und Lieferbedingungen, die unter www.xal.com eingesehen werden können, in der gültigen Fassung entgegengenommen.

