



The power of silence

Acoustic solutions





Silent power

A quiet environment is a core human need. Nevertheless, we are usually exposed to background noise from morning to night – from the ringing of the alarm clock to the conversational hum in modern open-plan offices. In the workplace, the quality of room acoustics is cited as one of the most important factors for one's well-being. Studies have shown that the acoustics of a room impact both productivity and the general quality of togetherness and one's health.

XAL's goal is to craft spaces where people feel relaxed, safe, and productive. To this end, we have developed a product portfolio in which lighting and room acoustics interact harmoniously. Acoustic lighting creates optimal lighting conditions and a balanced acoustic environment that enhances concentration, promotes social interaction, and creates an all-round sense of well-being.



Noise makes you ill

Our body releases stress hormones that make us ill over time.

Noise is a stress factor. This is evolutionary, as acoustic (warning) signals trigger fight or flight reactions. Due to the increased release of the stress hormones adrenaline and noradrenaline, the heart rate and blood pressure rise, which narrows the focus and provides the muscles with sufficient oxygen. The body compensates for this loss of energy by producing more cortisol, which increases blood fat and blood sugar levels. It is precisely these bodily processes that serve us in the short term but make us sick in the long term.

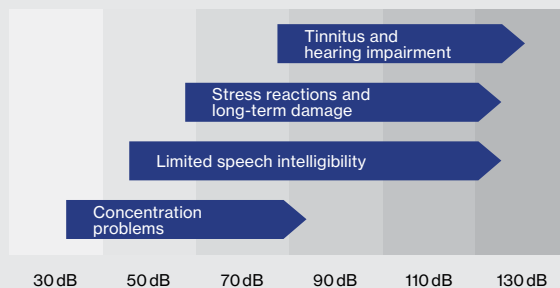

Unfortunately, the origin of the noise is irrelevant. Even if loud noises rarely mean danger to life today, the body still reacts in the same way. By making a significant contribution to reducing physical stress symptoms, quiet, balanced room acoustics have a positive long-term effect on health.



Noise is distracting

Even a whisper can interrupt concentration.

A whisper is only 30 dB, yet it affects both our mental state and our cognitive performance. Even after a minimal distraction at work, it takes an average of 25 minutes to get back to our original task and another eight minutes to return to our original concentration level.¹⁾

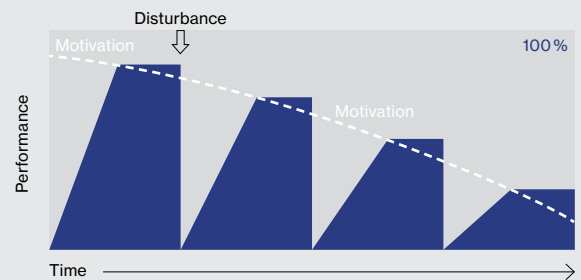

Researchers have found a term for this severe collapse and laborious recovery of performance level: the sawtooth effect. Good room acoustics increase concentration by minimising distracting noise.



Noise is isolating

The louder the environment, the more it impedes personal communication.

To satisfy one's need for privacy in large, open offices, the only option is often to withdraw and isolate oneself, for instance, by wearing headphones. In addition, personal contacts in open spaces are often reduced, as confidential one-on-one conversations are difficult. Compared to small offices, face-to-face communication in open-plan offices is reduced by approx. 70 %²⁾ and employees switch to email and instant messaging.

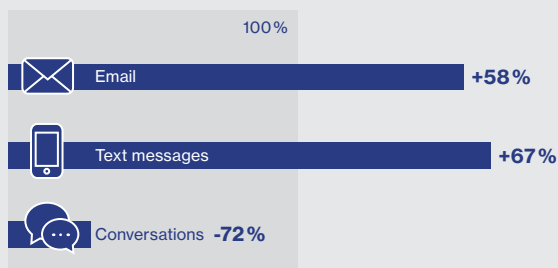

Balanced room acoustics limit sound propagation, thereby creating enough intimacy to hold face-to-face conversations even in multi-person offices. Thus, acoustic design is essential for a productive and social work environment where people feel connected and can interact.

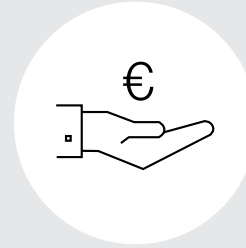

Noise costs money

We should not accept performance losses due to poor room acoustics.

In our knowledge economy, personnel costs have become the largest expense. Employees create added value through focused work and their cognitive performance. Good room acoustics improve the ability to concentrate; distractions and stress are reduced. Performance, measured by error rate and short-term memory, increases by up to 10 %.³⁾

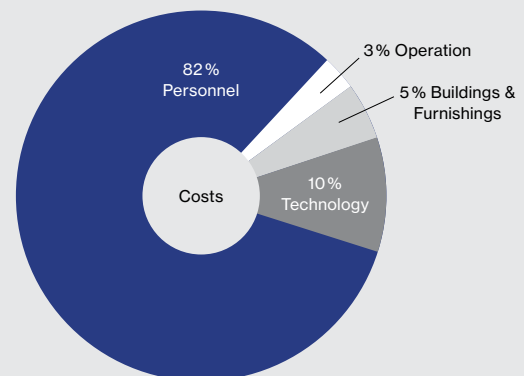

In this example calculation of an open-space office with 32 employees, we conservatively calculate only a 5% increase in performance with optimised room acoustics. What is nevertheless evident is that the cost savings achieved by optimising acoustics are worthwhile.

Monthly value added per staff member (SM) ⁴⁾	8.300 €
Additional monthly value added per SM with optimised acoustics (5%)	415 €
Monthly profit with optimised acoustics and 32 SM	13.280 €
Annual profit with optimised acoustics	159.360 €
Optimally equipped office using XAL MUSE (acoustics and light)	from 63.520 €

Sources

¹⁾ Gonzalez, Victor M.: "No Task Left Behind? Examining the Nature of Fragmented Work", 2005

²⁾ Bernstein, Ethan S. & Turban, Stephen: "The Impact of the 'Open' Workspace on Human Collaboration", 2018

³⁾ Sykes, David M.: "Productivity: How Acoustics Affect Workers' Performance In Offices & Open Areas", 2004

⁴⁾ According to the Austrian Chamber of Labour's balance sheet database, approx. €100,000 value added per employee in 2019.

AK-Wien, AK OÖ: Diagram "AK Wertschöpfungsbarometer, Überschuss Pro-Kopf-Wertschöpfung über Pro-Kopf-Personalaufwand in Euro", 2020

Acoustic solutions for all areas

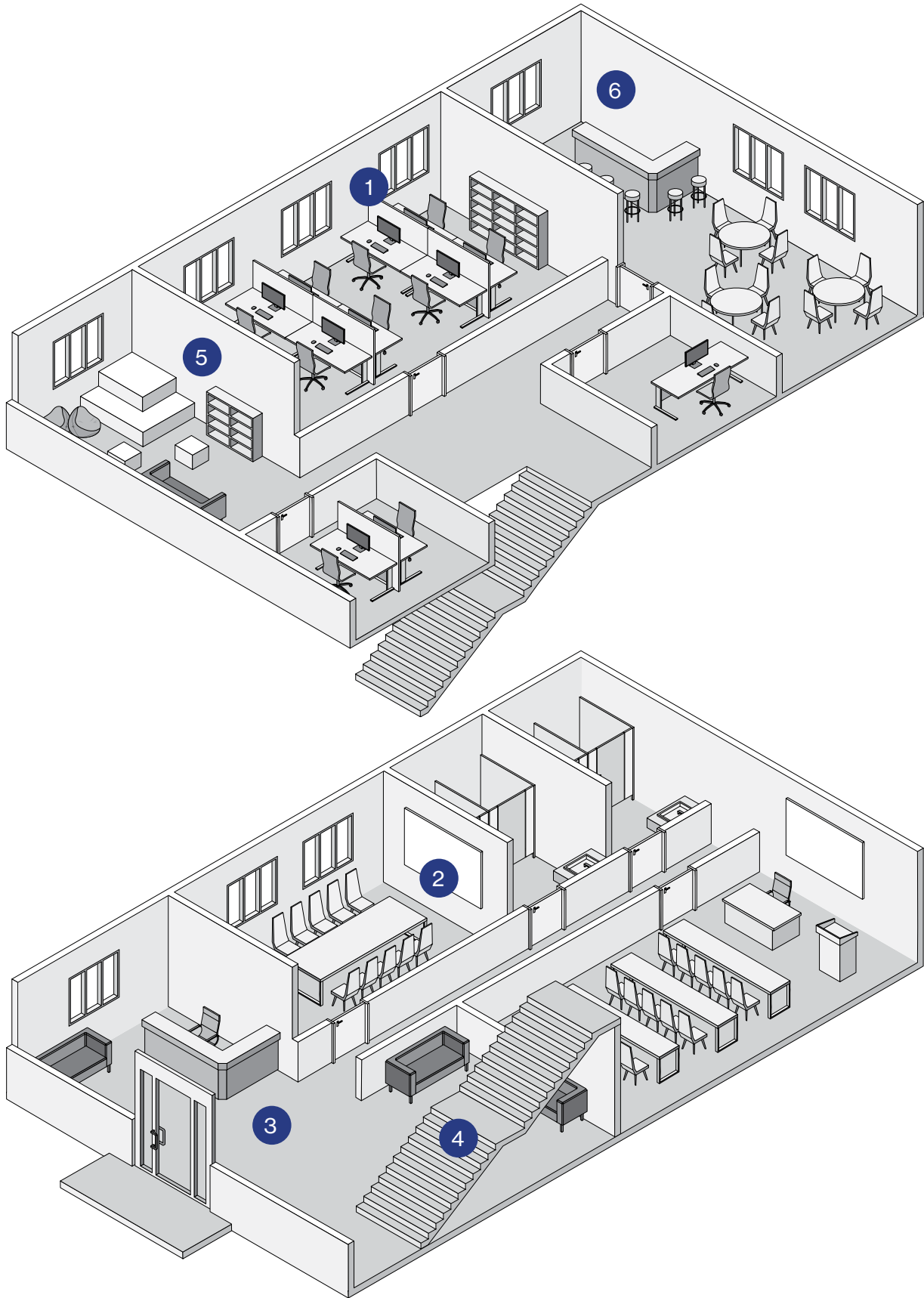

① Offices	➔ 14
② Meetings & conferences	➔ 22
③ Lobbies	➔ 28
④ Stairwells & corridors	➔ 34
⑤ Breakout areas	➔ 40
⑥ Canteens	➔ 46

Products	➔ 52
Acoustics in brief	➔ 66
Planning examples	➔ 40



Systematic thinking

Lighting and acoustics are elementary factors in room planning. XAL offers flexible, comprehensive solutions that combine both in one system. Depending on spatial requirements, luminaires and acoustic elements can be flexibly positioned and extended. Existing lighting systems can also be complemented by acoustic elements from the respective series. Last but not least, the system solutions allow separate installation of lighting and acoustic elements. The acoustic elements, which are sensitive to dirt, can thus be optimally arranged at the end of the construction phase and in already furnished rooms.

Custom colouring

Colours have a decisive influence on the effect of rooms and buildings. Their role is to support and tie together an architectural vision. That is why our lighting and acoustic solutions are available in a wide range of classic and modern colours. If you would like even greater design freedom, all of our acoustic elements can come in an individually chosen colour. The acoustic performance remains virtually unaffected.



Acoustic planning by XAL

Whether it's a new construction project or an acoustic retrofit, our room acoustics experts help you optimise your room acoustics and develop bespoke acoustic solutions. We look at each project holistically. Surfaces, materials, furnishings, and lighting are analysed to-

gether to create the best acoustic conditions in each room. Our focus is on creating work environments where people feel comfortable and perform at their best.

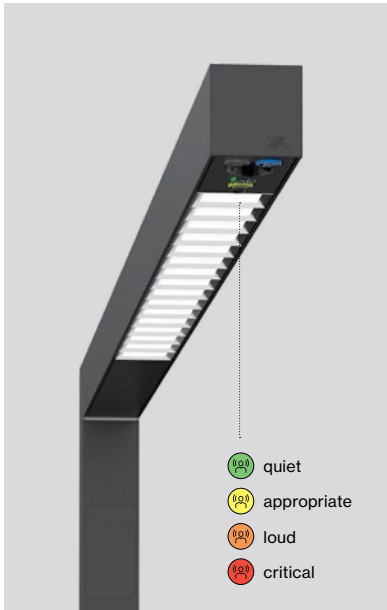

Smart acoustics

There are different ways to create a homogeneous room-acoustic atmosphere. We complement classic absorbers and sound screens with smart solutions such as our sound traffic light. Integrated in the BETO Standing workplace luminaire, this coloured LED discreetly draws attention when noise levels in the room are rising too high. The luminaire uses presence and daylight sensors to adjust its light output, and also indicates reserved workstations in shared co-working spaces.

Local, sustainable, safe



Our acoustic elements are made of a specially manufactured material: an artificial fleece made of recycled PET. This material combines three advantages. It is inherently stable, acoustically highly effective, and has a visually and haptically pleasant surface

quality. Our domestic partners specialise in forming the PET fleece into soft, rounded shapes, cutting it precisely or folding it like origami. For public spaces, special flame-retardant acoustic solutions offer maximum safety.

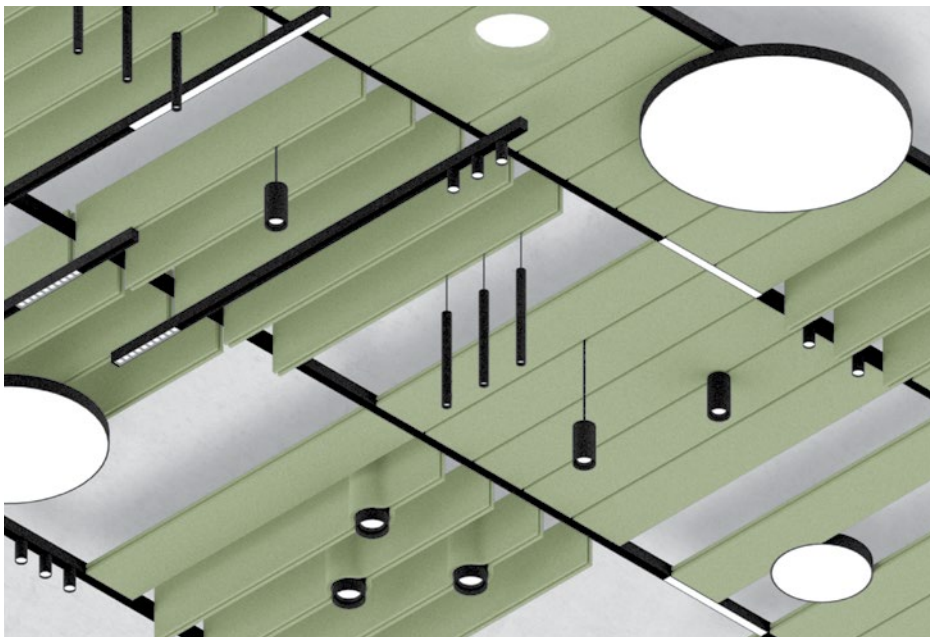

We are happy to offer you advice

Acoustic measures have a strong spatial presence. We are your partner for bespoke lighting and acoustic solutions, adapted to your project's architectural and aesthetic requirements. Whether it's minor dimensional or colour adjustments, or completely new developments, we support you from the planning stage through to implementation. Let's talk about your project: acoustics@xal.com

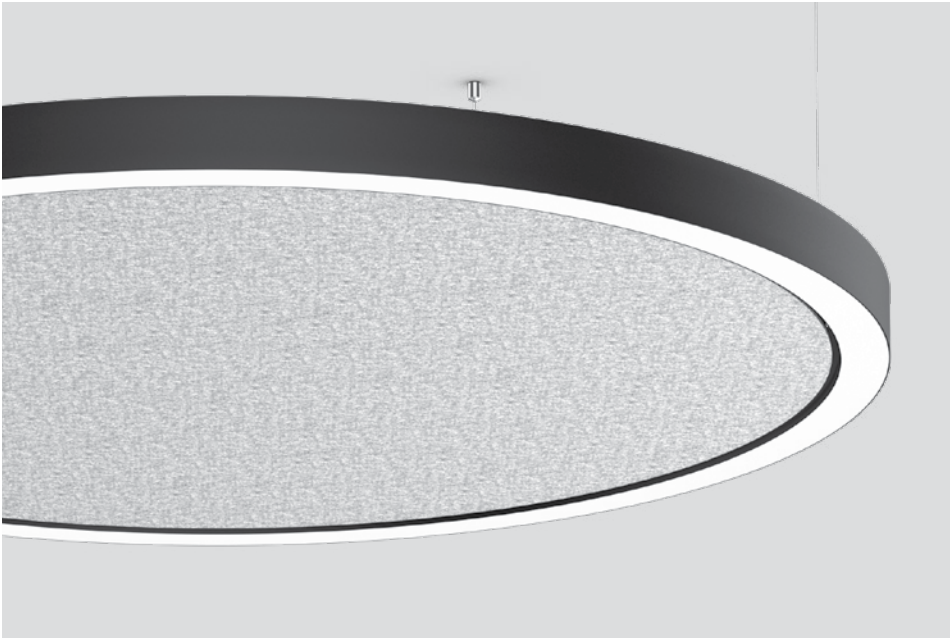

Light in perfect circles

MINO circle

ceiling/suspended

3000K, 4000K, TW (Tunable White)

Ideal applications

Offices, meetings & conferences, lobbies, stairwells & corridors, canteens

Colours

Luminaire: white, grey, black, gold and special colours

Acoustic elements: white, marble grey, black

Shaping the environment

HEX-O

ceiling/suspended

3000K, 4000K, TW (Tunable White)
UGR \leq 19

Ideal applications

Offices, meetings & conferences, lobbies, stairwells & corridors, breakout areas, canteens

Colours

Luminaire: white, black, and special colours

Acoustic elements: all acoustic colours

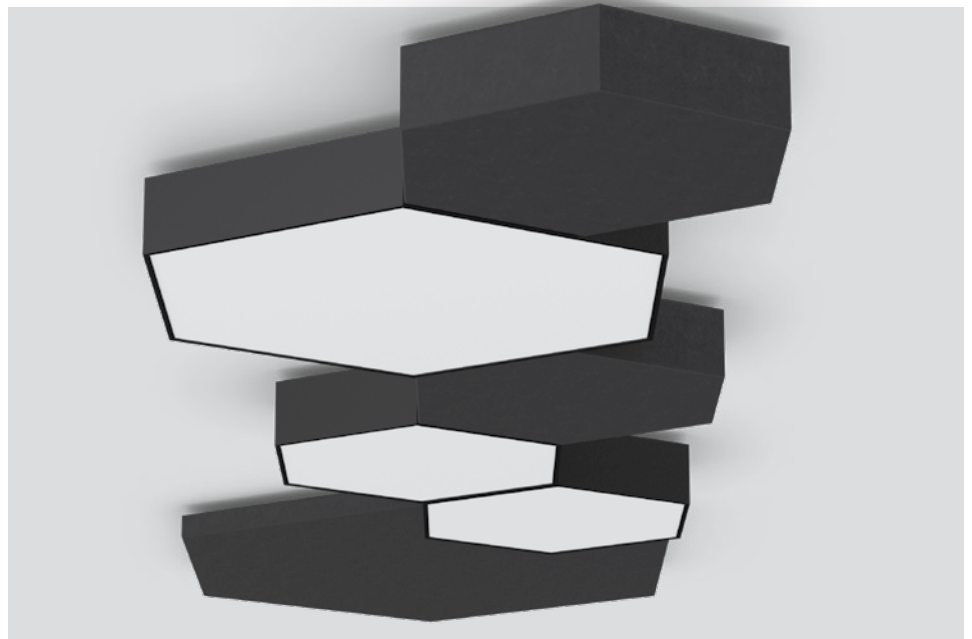

To the Products



TRIG-O

surface/suspended

3000K, 4000K, TW (Tunable White)
UGR \leq 19

Ideal applications

Offices, meetings & conferences, lobbies, stairwells & corridors, breakout areas, canteens

Colours

Luminaire: white, black, and special colours

Acoustic elements: all acoustic colours

Ultra slim series

TASK system

suspended

3000 K, 4000 K, TW (Tunable White)
UGR ≤ 19

Ideal applications

Meetings & conferences, lobbies,
stairwells & corridors, canteens

Colours

Luminaire: white, black
Acoustic elements: all acoustic colours

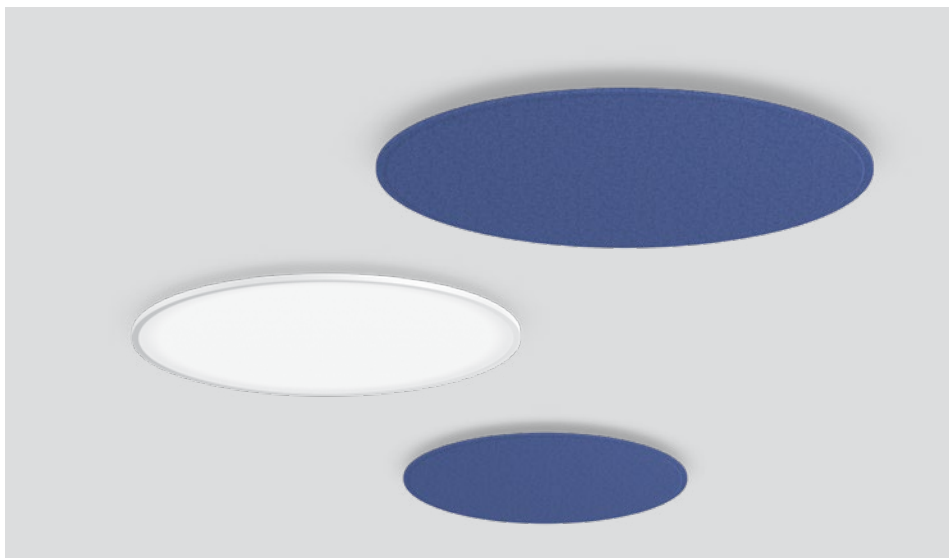

TASK round

surface/suspended

3000 K, 4000 K, TW (Tunable White)
UGR ≤ 19

Ideal applications

Offices, meetings & conferences, lobbies,
stairwells & corridors, breakout areas,
canteens

Colours

Luminaire: white, black, and special
colours
Acoustic elements: all acoustic colours

TASK square

surface/suspended

3000 K, 4000 K, TW (Tunable White)
UGR ≤ 19

Ideal applications

Offices, meetings & conferences,
lobbies, stairwells & corridors, breakout
areas, canteens

Colours

Luminaire: white, black, and
special colours
Acoustic elements: all acoustic colours

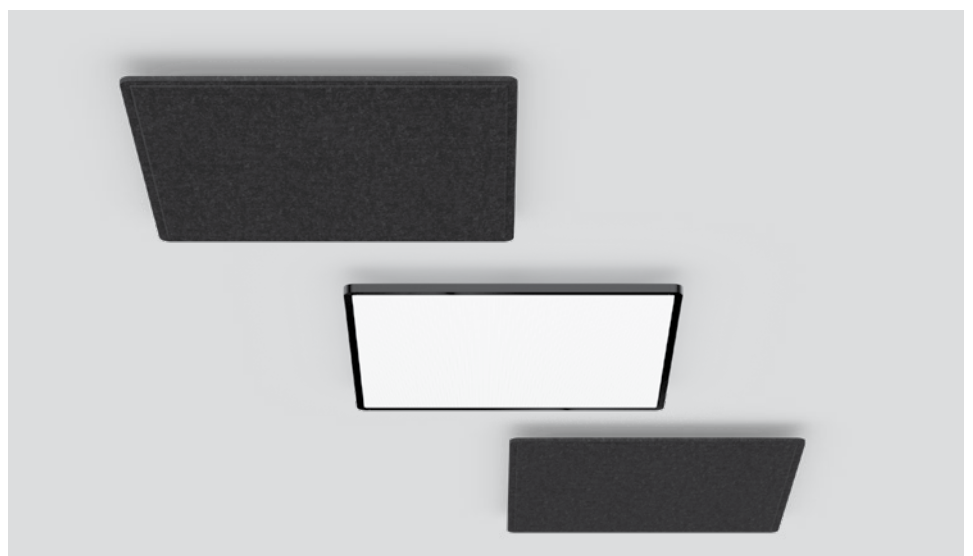



The sound of stress-free work

MUSE double light suspended

3000 K, 4000 K, TW (Tunable White)
UGR ≤ 19

Ideal applications
Offices, meetings & conferences,
breakout areas

Colours
Anthracite, felt grey, bright blue, indigo
blue

MUSE light/baffle suspended

3000K, 4000K, TW (Tunable White)
UGR ≤ 19

Ideal applications
Offices, meetings & conferences, break-
out areas, canteens

Colours
Anthracite, felt grey, bright blue, indigo
blue

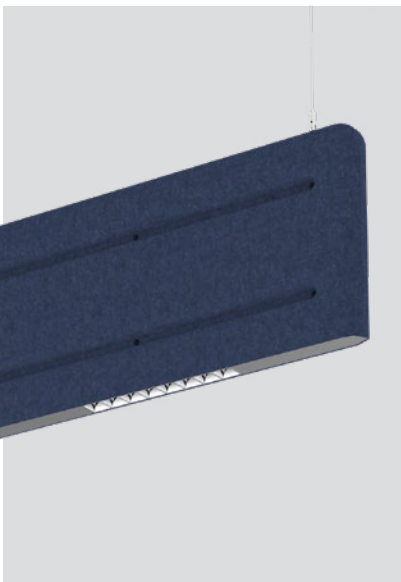

MUSE desk table mounted

3000 K, 4000 K, TW (Tunable White)
UGR ≤ 19

Ideal applications
Office, reception

Colours
Anthracite, felt grey, bright blue, indigo
blue

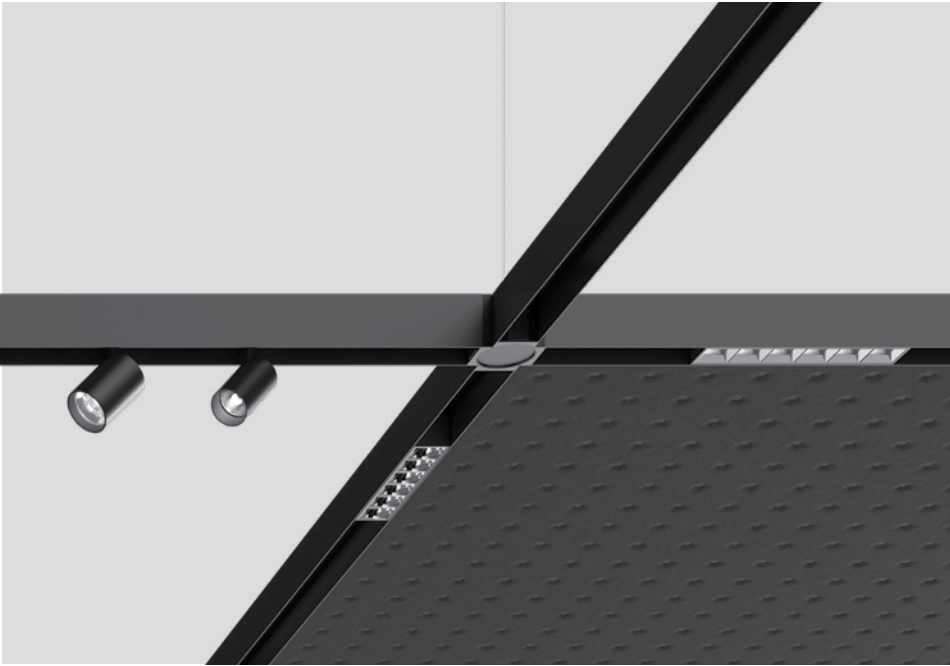

Everything on track

MOVE IT 25 / 45 system suspended

2700K, 3000K, 4000K, TW (Tunable White), UGR ≤ 19

Ideal applications
Offices, meetings & conferences, lobbies, stairwells & corridors, canteens

Colours
Luminaire: white, black, gold, and special colours
Acoustic elements: white, black

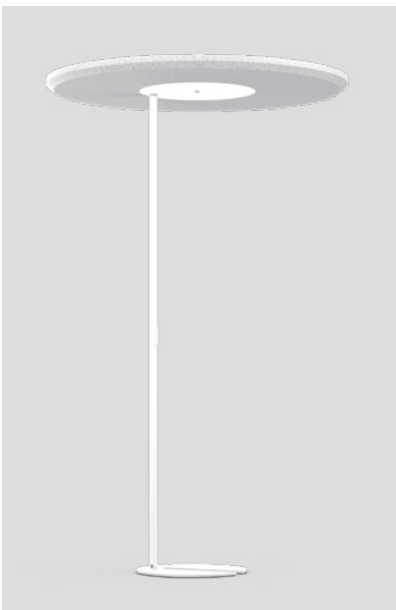

Enlightened by acoustics

SONIC suspended

3000K, 4000K, UGR ≤ 19

Ideal applications
Offices, meetings & conferences, lobbies, stairwells & corridors, breakout areas, canteens

Colours
Luminaire: white, dark grey, and special colours
Acoustic elements: white, marble grey, black

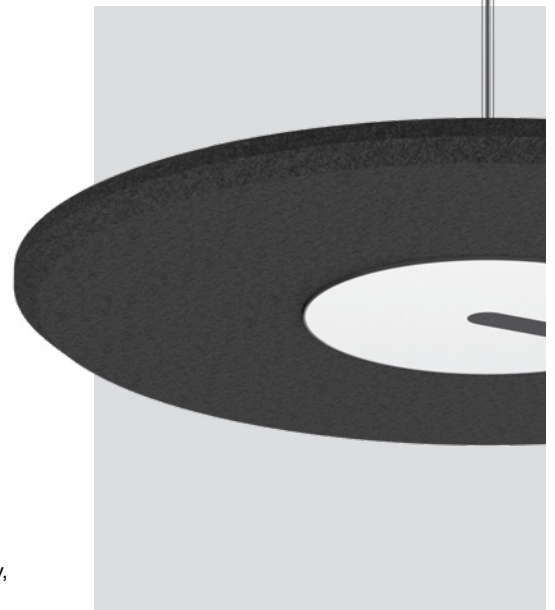

SONIC free standing

3000K, 4000K, TW (Tunable White)
UGR ≤ 19

Ideal applications
Office, reception, breakout areas

Colours
Luminaire: white, dark grey, and special colours
Acoustic elements: white, marble grey, black



SONIC soundcap suspended / free standing

3000K, 4000K, UGR ≤ 19

Ideal applications
Offices, meetings & conferences, lobbies, stairwells & corridors, breakout areas, canteens

Colours
Luminaire: white, dark grey, and special colours
Acoustic elements: all acoustic colours

Offices



Communication meets concentration

We have been experiencing a trend towards a communicative and agile working world in office design for years. In addition to optimising space, the open office landscape is expected to lead to increased professional exchange and more work-related flexibility. However, such open spaces raise acoustic challenges. Conversations require good speech intelligibility, while the rest of the team should be able to work in a focused manner.

The optimum reverberation time for open-plan offices is between 0.7 and 0.9 seconds in the frequencies relevant to speech. If the reverberation time is longer, a room is perceived as too loud. If it is shorter, speech intelligibility increases – but this is counterproductive in open offices, as it is distracting. The optimum average value is decisive for acoustic conditions that promote concentration.

In a well-balanced acoustic concept, the first step is to absorb disturbing sound to reduce reverberation. At the same time, sound screens and other vertically aligned acoustic elements prevent the propagation of speech in the room. This creates a sense of privacy without isolation.

Room-acoustic requirements (DIN 18041, VDI 2569)

- Room: large multi-person office of 3 m ceiling height
- Objective: room acoustics class B, level of sound propagation: 2
- Maximum reverberation time of 0.7 – 0.9 seconds
- Minimum reverberation time of 0.4 seconds
- A/V ratio minimum 0.23 (A/V ratio: ratio of absorption area to room volume)
- Spatial decay rate of speech at least 6 dB
- Sound pressure level of speech at a distance of 4 m maximum 49 dB

MUSE

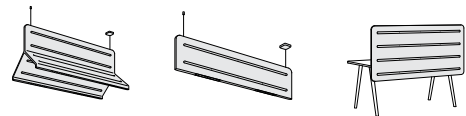

TASK

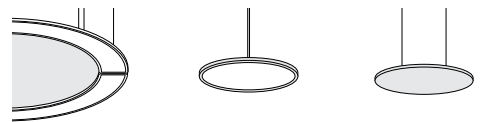

HEX-O / TRIG-O

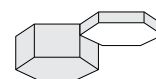

MOVE IT

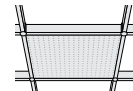



„We are very happy with the result. Visually, acoustically, and in terms of lighting, our expectations were more than exceeded”

Bernhard Stolberg, Owner

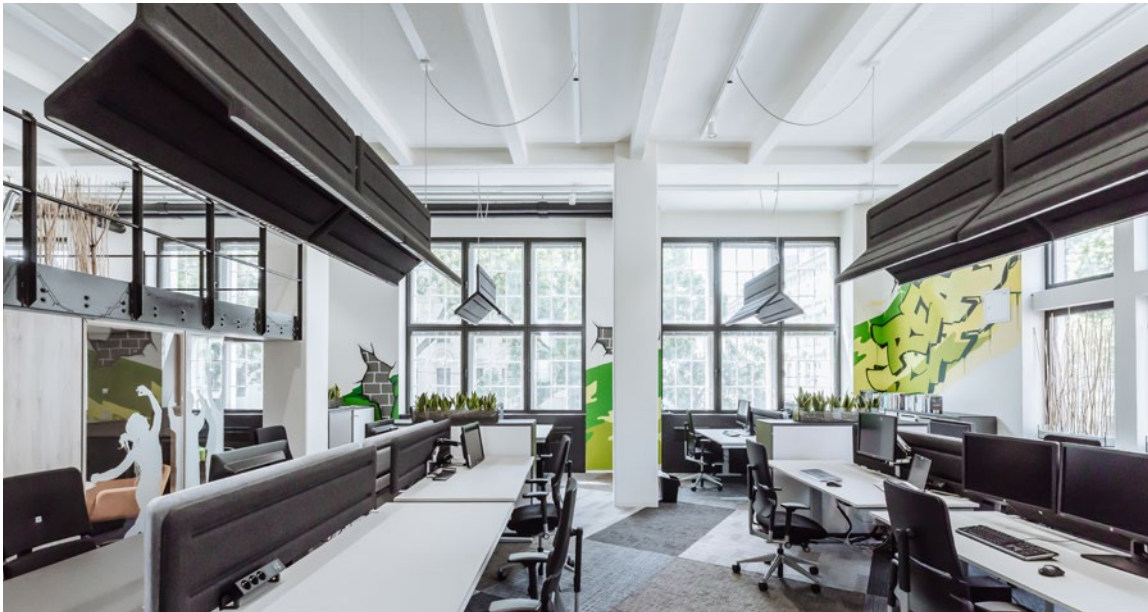

Acoustic performance in the office loft

Inter-pool Immobilien GmbH

As a specialist for office solutions and an exclusive real estate service provider in Vienna, Inter-pool have recently revitalised their office. The large loft with particularly high ceilings and hard surfaces was to be turned into an office with a feel-good factor by means of acoustic measures and also be usable as a showroom for customers. Workstations suitable for computer screens were created by suspending MUSE DOUBLE LIGHT above the desks.

The luminaires also boast sound-absorbing properties. In addition, the MUSE DESK elements, which were mounted in front of the desks, further improved the acoustic performance. The load-bearing capacity of the fire protection ceiling posed a particular challenge. All requirements were met thanks to the luminaires' low weight. A particularly pleasant atmosphere in the loft has been achieved by the different lighting moods.

XAL Office
New York City, US –
by INNOCAD architecture, Bettina Zerza
Architecture with lighting design by
INNOCAD architecture







Branded Graz, AT



Art Invest
Berlin, AT –
by LEPEL & LEPEL Architekt
Innenarchitektin Part GmbH



Meetings & conferences



Mutual intelligibility

Good mutual understanding determines a meeting's success. At meetings and conferences, the room acoustics should enable people to speak without straining and ensure that speakers are easily understood by other participants. This is especially true for telephone and video conferences, where strong reverberation quickly creates disturbing feedback effects.

The aim is to achieve uniform sound absorption, especially in the frequency range relevant to speech. Unpleasant flutter echoes can be avoided by equipping one of two opposite walls with absorbent material. In small meeting rooms, the placement of acoustic elements close to the sound source has proven to be effective, for example, directly above the conference table. In larger lecture rooms, sound-reflecting equipment in the middle of the ceiling is recommended so that speech can be easily understood all the way to the back rows.

Depending on the size of the meeting or conference room, the optimum reverberation time is between 0.4 and 0.7 seconds. For people with impaired hearing, it should be reduced even further in inclusive spaces, to a maximum of 0.3 to 0.5 seconds.

Room-acoustic requirements (DIN 18041)

- Room: 250 m³ volume
- Objective: room group A3
- Target reverberation time of 0.6 seconds
- Avoidance of flutter echo between two opposing walls
- Reflective surfaces to carry speech to the back rows

HEX-O / TRIG-O

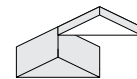
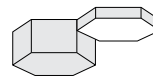

MINO

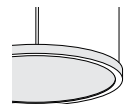

TASK

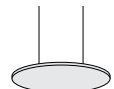
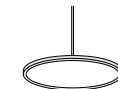
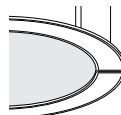

MUSE

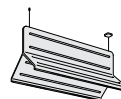

MOVE IT

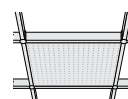

Visualisation
Meeting room







Magazin auf EF
Oer-Erkenschwick, DE



Lobbies



The first impression counts

In corporate buildings, the lobby is the first point of contact with the customer. This is why companies are increasingly focusing on modern architecture and reduction in design such as smooth, hard surfaces, large glass facades, and sparse decoration. This creates visual elegance but favours the propagation of sound. The targeted use of acoustic elements is crucial to ensure a certain level of confidentiality in the counter area.

The required sound absorption is determined by the ratio between absorbing surface and room volume. This so-called A/V ratio should be at least 0.13 in lobbies and entrance halls with comparatively short presence periods. Expansive, high spaces are best optimised by large-volume acoustic elements that are freely arranged in the room.

Additional measures are necessary to ensure that the reception staff also work under the best acoustic conditions. Individual acoustic solutions around the counter create an acoustically pleasant atmosphere and also mark it as a delimited zone, thus facilitating spatial orientation. Where special privacy requirements apply, such as at bank counters, sound screens in the form of desk panels and partitions act as additional absorbers.

Room-acoustic requirements (DIN 18041 / VDI 2569)

- Room: 4 m ceiling height
- Objective: room group B2
- A/V ratio minimum 0.13 (A/V ratio: ratio of absorption area to room volume)
- Creation of acoustic privacy in the reception area

HEX-O / TRIG-O

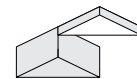
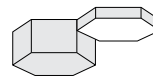

SONIC

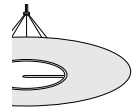

TASK

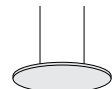
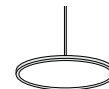

OLX Group Poznań, PL –
by Trzop Architekci with lighting
design by Pluslighting







Planday Copenhagen, DK –
with lighting design by anker & co

Compound Semiconductor Applications Catapult
Wales, UK – by Monteith Scott



Stairwells & corridors



Meeting point and circulation link

Often given secondary consideration, stairwells and corridors are the core of a building. As meeting areas, they are the backdrop for informal but important communication, especially where people remain for extended periods. If sound levels here are high, this disturbs the people present on site and also those in adjacent rooms.

Therefore, the room acoustics in corridors and stairwells deserve special attention. Freely arrangeable acoustic elements are ideal here, as they can be placed exactly where they are needed while setting interior design accents. The required absorption is determined by the A/V ratio, which is the ratio between sound absorbing surface and room size. This should be at least 0.13 in corridors and stairwells.

Room-acoustic requirements (DIN 18041 / VDI 2569)

- Room: 4m ceiling height
- Objective: room group B2
- A/V ratio minimum 0.13 (A/V ratio: ratio of absorption area to room volume)
- Targeted use of acoustic elements in waiting areas

TASK

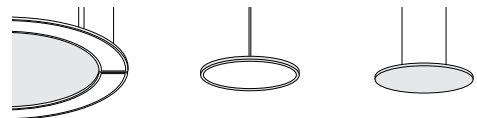

MINO

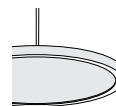

SONIC



HEX-O / TRIG-O

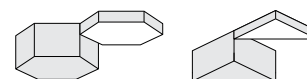





Friendly spaceship

EANS Flight Control

Together with XAL's Estonian partner Valgustus, KAMP Architects developed the lighting concept for the EANS Flight Control Centre. The building opened in May 2019.

The client was particularly exacting in terms of lighting in offices, in the corridors, and lobby. The extensive use of modern, hard surfaces in the interior – glass walls in the office area, exposed concrete, and white terrazzo floors – also posed a major challenge to room acoustics. The choice fell on a lighting and acoustic solution with a futuristic design character, namely XAL's HEX-O.

The HEX-O series' design fits wonderfully into the black and white interiors. Sculpturally, the hexagonal bodies run through offices, corridors, waiting areas, and are above all also used in the lobby, where there have already been several jazz concerts.

„As it turns out, the acoustics in the lobby are really good. There have already been some jazz concerts.“

Peeter Loo, Kamp Architect





Breakout areas



Retreats in open space

Social exchange and communication have become indispensable in the new world of work. Small booths, breakout spaces, or breakout areas create "islands" and places of retreat in open-plan offices. As a result, they offer a spatial interruption and time-out from the stimulating and dynamic environment of the open space. Breakout areas provide the framework for informal exchange, networking, and collaboration. As such they represent an important addition to the concept of "new work".

In the breakout areas, the aim is to create a confidential working environment and sufficient privacy for meetings or simply social interaction. Acoustic solutions ought to support the idea of an open innovation space, inviting brainstorming and informal exchange. Upholstered seating is a functional design choice that provides physical comfort and basic acoustic dampening. These are ideally complemented by suspended acoustic elements which both enhance acoustic performance and convey the feeling of a protected space. The acoustic requirements in the breakout zones are comparable to those in small meeting rooms. Therefore, a reverberation time of 0.4 to 0.7 seconds is targeted.

Room-acoustic requirements (DIN 18041, VDI 2569)

- Room: 3.5m ceiling height
- Objective: room group B4
- A/V ratio minimum 0.21
- Acoustic privacy for confidential conversations
- Suspended acoustic elements for improved well-being

TASK

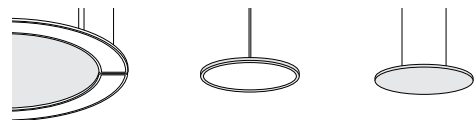

HEX-O / TRIG-O

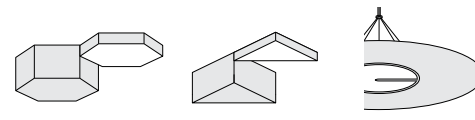

SONIC

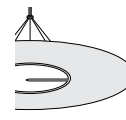

Office Space Oracle

Vienna, AT – by DI Stephan Kopinits







MERCEDES BENZ Lounge Geneva, CH –
by Kauffmann Theilig & Partner with lighting
design by TLD Planungsgruppe GmbH



Canteens



Coming together

Cafeterias naturally have a high noise level. Many people come and go, meet, and talk. In addition to the sound caused by conversations, a constant background noise is created by eating and drinking, the clinking of dishes, moving chairs, or rolling tray trolleys.

To create a pleasant conversational atmosphere, the reverberation in canteens must be significantly reduced. Distributing absorbing acoustic elements evenly on the ceiling as well as on the walls of the canteen supports a balanced acoustic environment. This also avoids stress caused by noise. People return to work refreshed and regenerated after their lunch break.

Room-acoustic requirements (DIN 18041)

- Room: 250 m³ volume
- Objective: room group A3
- Target reverberation time 0.6 seconds
- Even distribution of acoustic elements on ceiling and walls as far as possible

MOVE IT

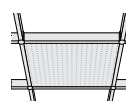

MINO

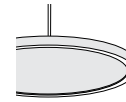

SONIC



HEX-O / TRIG-O

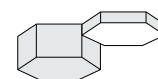

XAL GmbH Graz, AT –
by INNOCAD architecture





Cadence, IL –
by Hadas Makov with lighting design
by Orly Avron Alkabetz





The sound of stress-free work



MUSE

Professional office workplace lighting, virtually glare-free and brilliant, coupled with optimised room acoustics for a stress-free, focused working environment. MUSE is a product we developed for holistic lighting and acoustic concepts for offices. All elements of the five-part product family effectively optimise the room acoustics. The two luminous versions also create standardised screen-compatible workplace lighting in accordance with DIN EN 12464-1 with a UGR ≤ 19 , thanks to high-quality reflectors with faceted optics.

MUSE is a self-confident element in the office with its characteristic design language, the different colours, and the haptically appealing surface. Through the combination of light and acoustics, MUSE positively impacts the most important factors influencing well-being and performance in the workplace.

Types

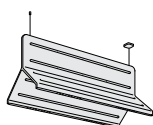

acoustic suspended double light

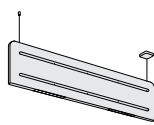

acoustic suspended light

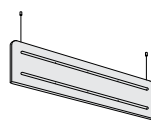

acoustic suspended baffle



acoustic table mounted desk low

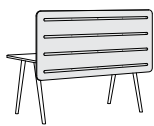

acoustic table mounted desk high

Lighting

3000 K, 4000 K
UGR ≤ 19

Sizes

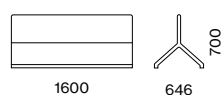

Colours



Acoustics

PET felt
♻️ from recycled material
up to absorption class A

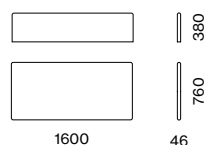

Shaping the environment

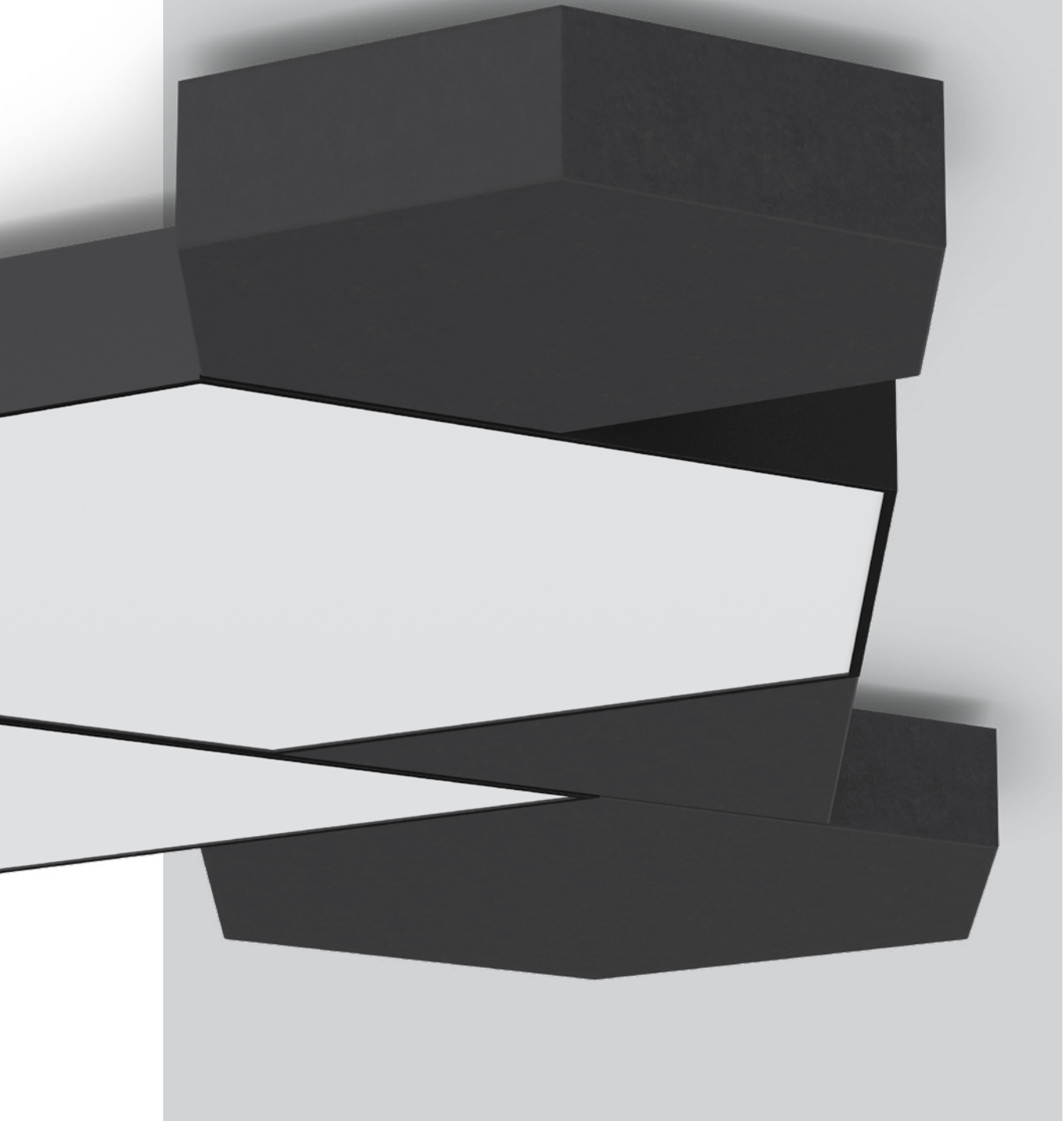

HEX-O/TRIG-O

HEX-O and TRIG-O are sculptural light-acoustic solutions which boast a modern design while fulfilling the two essential functions of lighting and room acoustics. State-of-the-art LED technology meets highly efficient acoustic elements to create an optimal working environment. The microprismatic cover provides glare-free light with a $UGR \leq 19$.

HEX-O and TRIG-O with an opal cover deliver pleasantly homogeneous room illumination. The combinable triangular and hexagonal acoustic elements made of 60% recycled PET fleece have multiple effects through absorption, damping, and diffusion for all-round balanced room acoustics.

Types

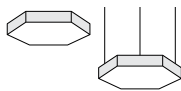

luminaire ceiling/suspended

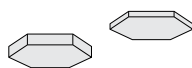

module/module flat ceiling/suspended

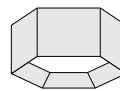

absorber ceiling/suspended

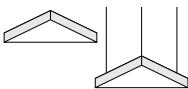

luminaire ceiling/suspended

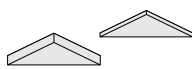

module/module flat ceiling/suspended

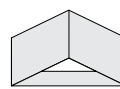

absorber ceiling/suspended

Lighting

3000K, 4000K
 $UGR \leq 19$

Sizes

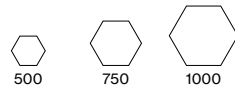

Luminaire colours



Acoustics

PET felt
♻️ from recycled material
up to absorption class A



Acoustic colours

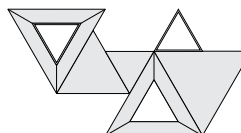
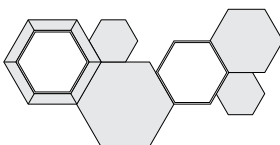

Everything on track



MOVE IT 25/MOVE IT 45

The MOVE IT 25 and MOVE IT 45 track systems offer maximum flexibility and infinite combination options. Spotlights, glare-free office inserts, and decorative luminaires can be mounted in the system without tools and flexibly adapted to spatial changes. With just one track system and the appropriate inserts, different areas in the office, such as workstations, meeting rooms, and corridors, can be individually illuminated and controlled at will.

The individual profiles can be interconnected or connected via NODE connectors. This allows for a variety of creative ceiling patterns. This comprehensive system is complemented by highly absorbent acoustic elements. Square or triangular in form, they can be hooked in wherever they are needed at any time without the need for tools.

Types

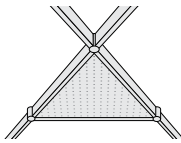

MOVE IT 25
acoustic triangle
suspended

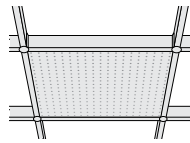

MOVE IT 25/45
acoustic square
suspended

Lighting

3000K, 4000K
UGR ≤ 19

Acoustics

PET felt
♻️ from recycled material
up to absorption class A

Sizes

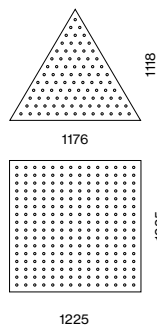

Track colours



Acoustic colours

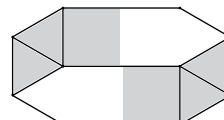
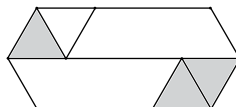
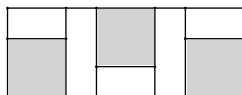

Enlightened by acoustics



SONIC

SONIC optimises lighting and room acoustics in one. The optional acoustic elements emphasise the luminaire's modern design and have a sound-absorbing effect. The cover with embossed microprisms promises excellent lighting quality and light suitable for the workplace. SONIC is available in 3000K or 4000K light colours. It can also be selected as a free-standing luminaire with a brightness and motion sensor making the luminaire react actively and energy-efficiently to its environment.

Types



suspended / free standing luminaires

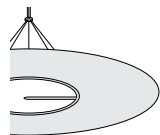

suspended absorber

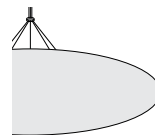

suspended absorber panel

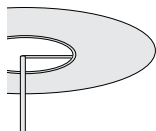

free standing absorber



suspended soundcap

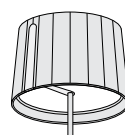

free standing soundcap

Lighting

3000K, 4000K
UGR ≤ 19
daylight & movement sensor

Luminaire size



Luminaire colours



Acoustics

PET felt
♻️ from recycled material

Acoustic size

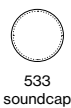
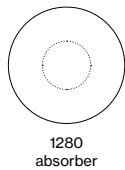

Absorber colours



Soundcap colours

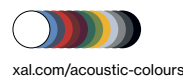

Creative freedom

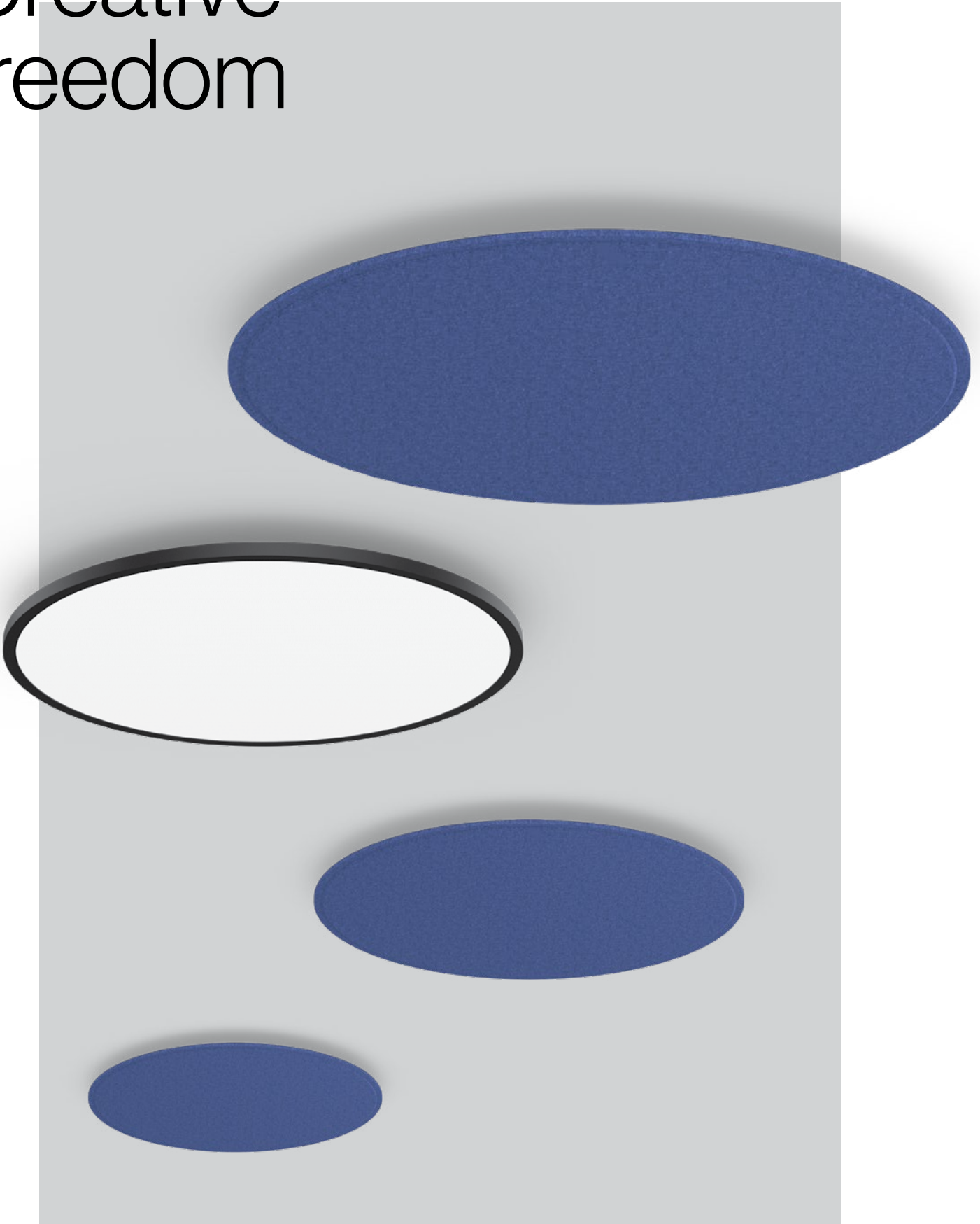

TASK/TASK S

The TASK series meets all the requirements of modern office lighting. Thanks to its microprismatic cover, TASK delivers a brilliant and glare-minimised workplace light. The TASK ROUND and TASK SQUARE minimalist luminaires are complemented by highly effective, visually matching acoustic elements. Thus, the series offers countless ceiling- and wall-design constellations, from freely arranged round elements of various sizes to strict grids of light and acoustic elements.

Types

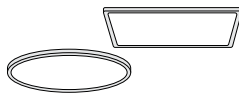

round/square
surface

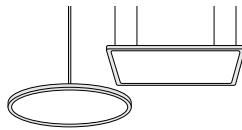

round/square
suspended

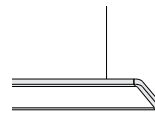

TASK S
suspended

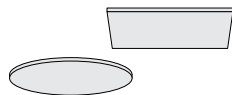

acoustic round/square
surface

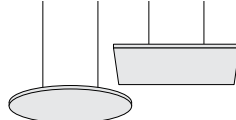

acoustic round/square
suspended

Lighting

3000 K, 4000 K, TW
UGR ≤ 19

Luminaire sizes

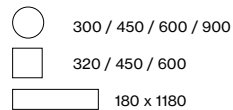

Luminaire colours

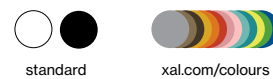

Acoustics

PET felt
♻️ from recycled material
up to absorption class A

Acoustic sizes

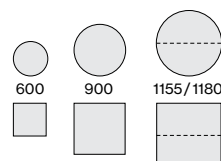

Acoustic colours



Ultra-slim series



TASK SYSTEM

The ultra-slim TASK series combines innovative technology and highly efficient LEDs with minimalist design. Corner elements and quarter-circle segments can form larger round or rectangular systems. Highly effective acoustic elements can be retrofitted to create optimal acoustic conditions. The optional indirect light provides pleasant ceiling illumination.

TASK CIRCLE and TASK ANGULAR combined with acoustic elements are ideal for the high-quality furnishing of prestigious meeting rooms.

Types

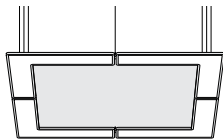

angular
suspended



long angular
suspended

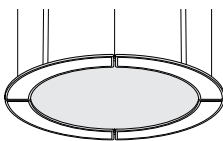

circle
suspended



long circle
suspended

Lighting

3000K, 4000K
UGR ≤ 19
daylight & movement sensor

Sizes

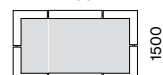
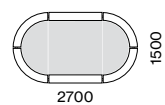
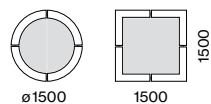

Luminaire colours

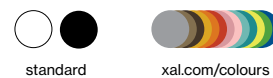

Acoustics

PET felt
♻️ from recycled material
up to absorption class A

Acoustic colours



In perfect circles

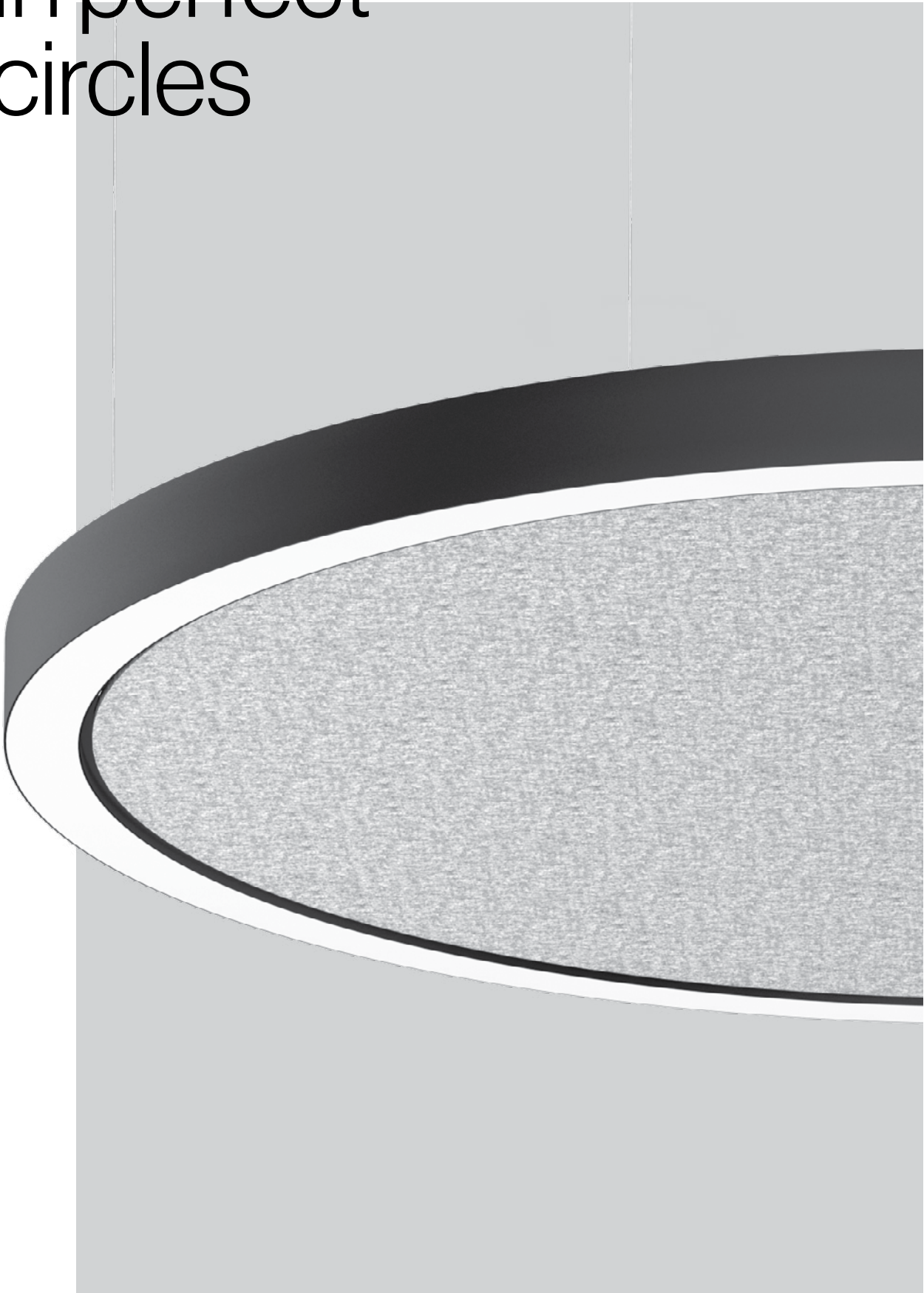

MINO CIRCLE

The aesthetic circular arrangement of MINO CIRCLE variants in different sizes and colours allows interesting, ever-changing ceiling patterns and figures. Combine the circular luminaires with highly effective round absorbers to create optimal acoustic conditions. MINO CIRCLE with its indirect distribution characteristic provides enough light where additional ceiling illumination is required. For homogeneous illumination, choose luminaires with an opal cover; the microprismatic cover ensures ideal working light. You can also choose between 3000K and 4000K light colours.

Types

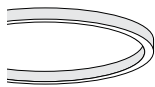

luminaire ceiling

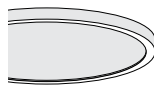

acoustic inlay ceiling

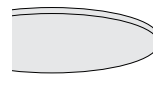

acoustic panel ceiling

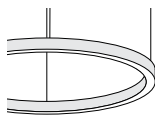

luminaire suspended

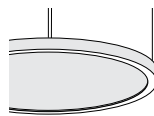

acoustic inlay suspended

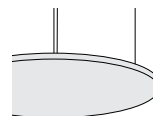

acoustic panel suspended

Lighting

3000 K, 4000 K
UGR ≤ 19
daylight & movement sensor

Sizes

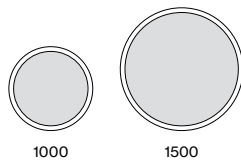

1000

1500

Luminaire colours



standard

xal.com/colours

Acoustics

PET felt
♻️ from recycled material
up to absorption class A

Acoustic colours



What are acoustics?

Sound

Sound is generally defined as an oscillation that propagates within an elastic medium as a sound wave. In the air, sound causes pressure and density fluctuations. These fluctuations move in waves and spread out spherically from the sound source.

Tight, fast sound waves have a high frequency (e.g., beeps), while wide, slow waves have a low frequency (e.g. humming noises). The shorter the wavelength λ , the higher the tone (frequency). The higher the amplitude A , the louder the sound (sound pressure level).

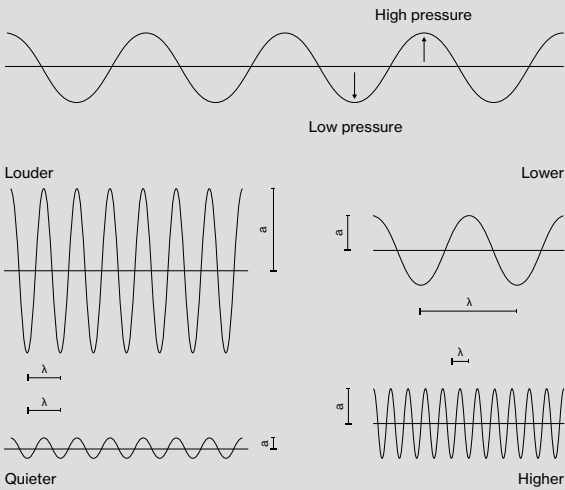

Noise

Noise is the greatest source of stress in modern office environments. However, since the perception of noise is very subjective, noise as a stress factor cannot be measured. It is therefore all the more important to consider both the volume and the quality of the background noise when designing optimal room acoustics in the workspace. Conversations, for example, are perceived as much more irritating than monotonous traffic noise of the same volume.

"Noise is the sound of others."

Kurt Tucholsky

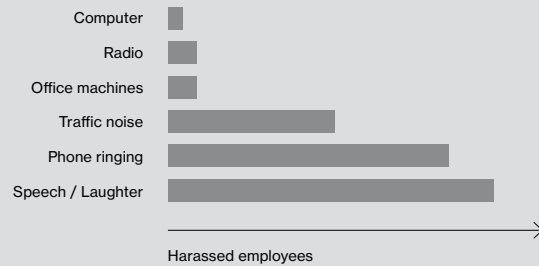

The Irrelevant Sound Effect describes the negative influence of vocal ambient noise on our performance, regardless of whether we understand the speech. If the brain isolates individual voices from a babble of voices to follow a conversation, this is known as the cocktail party effect. Because of these two phenomena, conversations are the greatest source of distraction in offices and are a key challenge in acoustic design.

Volume / sound pressure level

The sound pressure level indicates the volume of a sound and is measured in decibels (dB). The human hearing range is between 0 dB (hearing threshold) and 130 dB (pain threshold) and strongly depends on frequency.

A level of 10 dB corresponds to a normal breathing noise; leaves rustling have a volume of about 30 dB. In an expansive open space, the background noise can easily reach 70 to 75 dB, and hearing protection is required by law for workplace noise levels above 85 dB. The human pain threshold is in the range of 130 dB; this corresponds approximately to the volume of a jet taking off nearby.

A baby can produce up to 110 decibels (dB) to make itself heard. As loud noises are considered stressful and harmful, hearing protection at the workplace is mandatory from 85 dB.

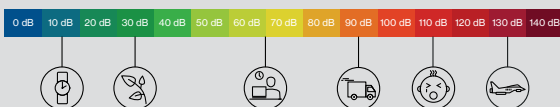

Pitch / frequency

The frequency, measured in Hertz (Hz), denotes the pitch. The human hearing range is between about 20 Hz and 20,000 Hz. Frequencies below this are referred to as infrasound (e.g. the hearing range of elephants), frequencies above this range are referred to as ultrasound (e.g. the hearing range of bats).

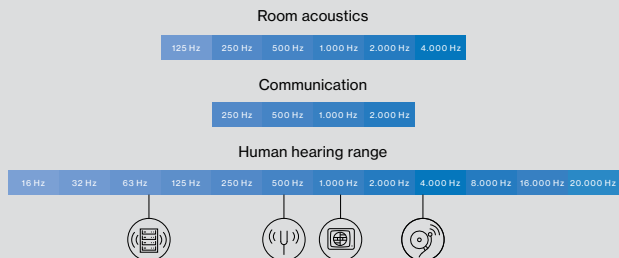

The frequencies relevant to communication range from approx. 200 Hz to 2,000 Hz. In room acoustics, we typically consider frequencies from 125 Hz to 4,000 Hz when creating optimal sound conditions. High frequencies are perceived particularly intensively by the human ear. The auditory system is most sensitive in the range between 2,000 Hz and 4,000 Hz.

Measures in room acoustics

Absorb

In absorption, sound waves are absorbed by a material and their energy is converted into heat by friction. The absorption coefficient ranges from 0 to 1 and indicates how well a material absorbs sound. An absorption coefficient of 1 corresponds to complete absorption. Typically, acoustic products and materials have different absorbing properties depending on the frequency range. To assess the overall absorption coefficient, the values should therefore be considered in each case for the frequency ranges from 125 Hz to 4,000 Hz.

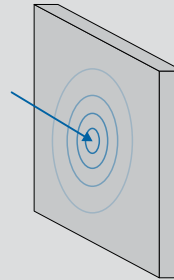

Block

Sound screens are used to reduce the propagation of sound in a room. Potentially distracting conversations are thus not carried throughout the room. Vertical screens also provide privacy and a sense of confidentiality. For such screens to be effective, they must be of a certain height. Special absorbent screens can further increase their effectiveness.

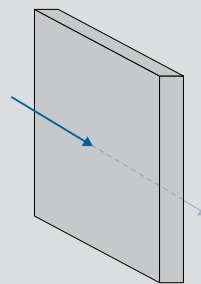

Scatter

Sound waves that hit a hard and smooth surface are reflected by it back into the room. Uneven surfaces or three-dimensional structures do not reflect incident sound waves linearly, but in different directions. This distributes the sound evenly in the room and creates a diffuse sound field, which is generally perceived as more natural and pleasant.

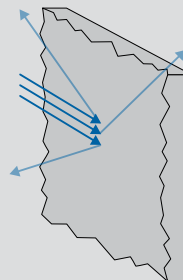

Examples based on products

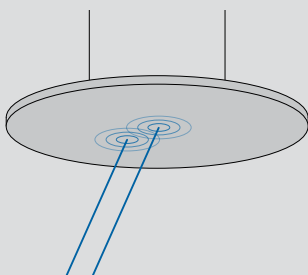

TASK
Absorbing

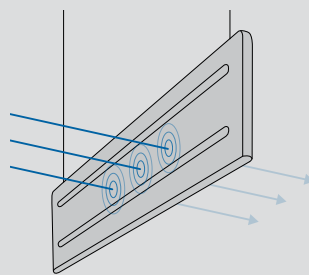

MUSE
Absorbing
Blocking

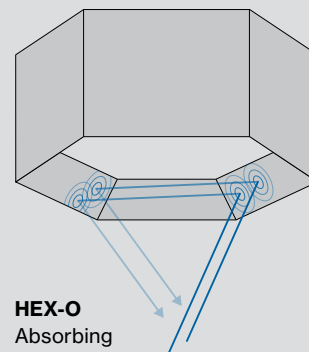

HEX-O
Absorbing
Scattering

The end of the grid ceiling?

Why flexible acoustic elements are now the better solution.

In modern office environments, the continuous acoustic grid ceiling is no longer state-of-the-art. It often cannot be implemented if, for example, the core-activated ceiling in new buildings has to remain unobstructed. Partial acoustic solutions are particularly flexible, even for structural retrofits, and adapt to increasingly agile working environments.

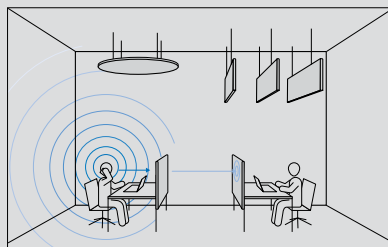
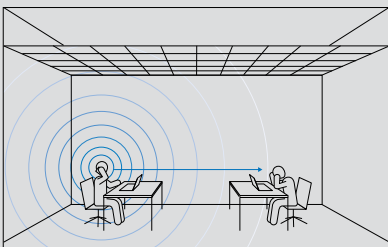
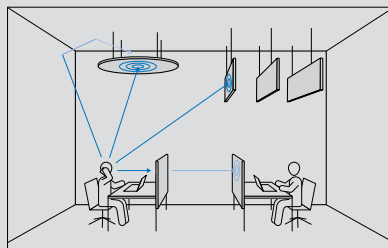
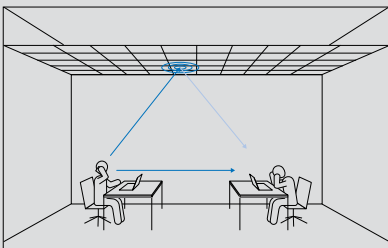
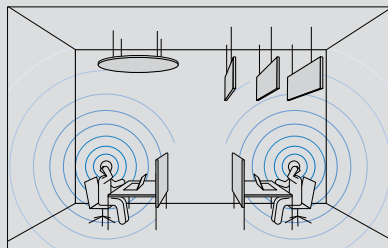
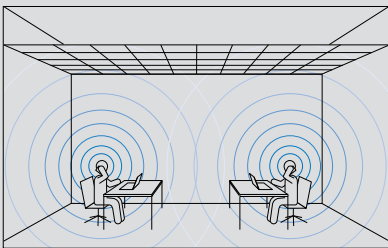
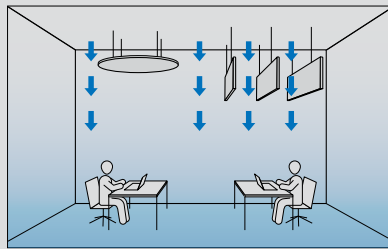
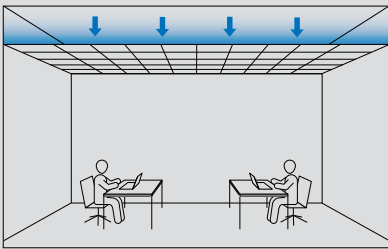

Better air circulation in open space

With a core-activated ceiling, the suspended grid ceiling prevents effective heating or cooling. One advantage of individual acoustic elements is that they allow good air circulation and thus have a positive effect on the room's climate.

Placement close to the source

By installing acoustic solutions close to the sound source, the propagation of noise in the room is inhibited at an early stage.

Small area, big effect

Suspended acoustic solutions automatically save space by using the sound-absorbing effect of their front and back. Baffles and desk panels also achieve maximum efficiency with a small surface area thanks to their absorption on both sides.

Improved concentration due to reduced vocal sound

Vertical structures prevent the propagation of vocal sound in the room. This is particularly important in offices, where speech noise and excessive speech intelligibility have a particularly disruptive effect on concentration.

Key parameters in room acoustics

Reverberation

Reverberation is one of the most important factors for evaluating room acoustics. When sound waves are reflected from hard surfaces, an acoustic reverberation occurs.

The reverberation time measures a room's sound decay in seconds. In a church, for example, there is a long reverberation time of several seconds, whereas in a recording studio it is very short at around 0.3 seconds. By definition, the reverberation time is the time it takes for a sound event to decay by 60dB. One therefore also speaks of RT60, "Reverberation Time 60".

People intuitively speak more loudly in reverberant rooms.

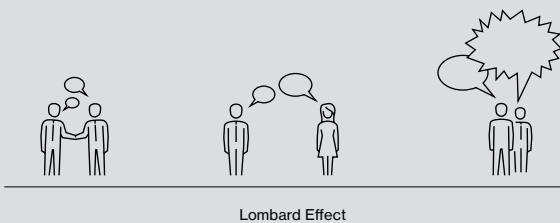

In addition to the reverberation time, the reverberation in a room can also be defined by the A/V ratio. This indicates the relation between the available sound absorption area and the room volume. The reverberation time has a direct influence on speech intelligibility. The shorter it is, the more intelligible the language.

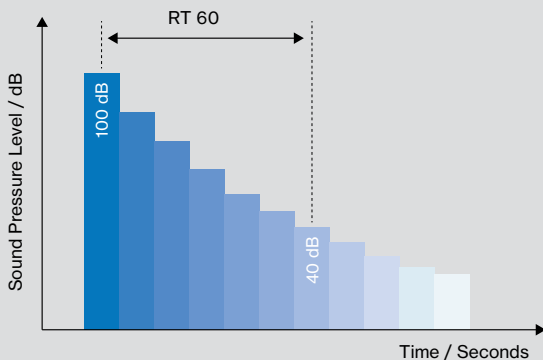

Sound propagation

Depending on a room's use, the reverberation, sound propagation, and thus speech intelligibility must be considered. Vocal sound is a major disruptive factor, especially in offices. Consciously perceived conversations interrupt concentration and increase the error rate.

The Speech Transmission Index (STI) rates speech intelligibility from 0 (unintelligible) to 1 (excellent intelligibility). While good speech intelligibility is desirable in conference rooms, it is a distraction in offices. The STI should not exceed 0.5 over as large a range as possible.

Further parameters for the dimensioning of sound propagation are the spatial decay rate of speech ($D_{2,S}$) and the sound pressure level of speech at a distance of 4 m ($L_{p,A,S,4m}$).

In offices spaces, excessive speech intelligibility is distracting.

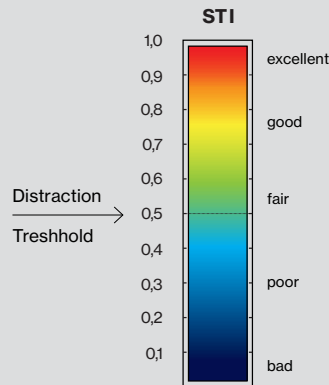
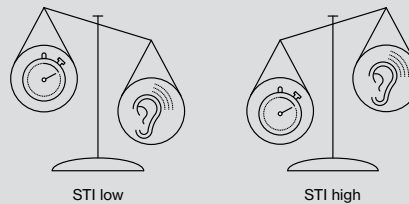

DIN 18041

DIN 18041 distinguishes between the two room groups A (medium and long distances) and B (short distances).

For office spaces, room group B applies. Depending on the acoustic requirements, there is an additional classification into the usage types B1 to B5. Depending on the room height and type of use, DIN gives a recommendation for the minimum A/V ratio. Office spaces fall into use type B4 and should have an A/V ratio of at least 0.23 for a ceiling height of 3m.

ÖNORM B 8115-3, Part 3: Room acoustics is based on DIN 18041.

VDI 2569

VDI 2569 provides recommendations for the acoustic design of office spaces.

For large office spaces, in addition to the A/V ratio recommended in DIN 18041, the reverberation time (RT60), the spatial decay rate of speech ($D_{2,S}$), and the sound pressure level of speech at a distance of 4 m ($L_{p,A,S,4m}$) must also be considered.

Depending on the length of the reverberation time, offices are assigned to room acoustics classes A (short reverberation time) to C (longer reverberation time). In addition, the sound propagation is divided into stages 1-3. Level 1 has the lowest sound propagation.

Multi-person office planning example

Room acoustics have a major influence on our well-being and performance. Because noise and disturbing sounds impair concentration and cause stress, one of the central challenges in planning is to create a quiet and balanced acoustic working atmosphere. This is especially true for open-plan and multi-person offices. Since people work here and communicate with each other, the room acoustics must reconcile the two conflicting needs of quiet and communication. In addition to the general volume, reverberation and sound propagation must be reduced to minimise distractions.

On the following pages you will find a selection of different light and acoustic simulations in a typical multi-person office with common structural conditions. It is a 112 m² office space, divided into six working clusters with four employees each. The group areas are divided by sideboards. Both strict grid arrangements and freely placed acoustic elements are simulated. Lighting and acoustic elements were either combined as separate products or used as a joint solution.

Acoustic requirements

According to DIN 18041, office spaces fall into room group B4 (rooms requiring noise reduction and room comfort). Thus, the necessary attenuation is specified based on the A/V ratio (ratio of absorption area A to room volume V). VDI 2569 also gives recommendations for the reverberation time and the interference sound level of on-site noises. Depending on the values achieved, the VDI thus classifies rooms into room acoustics classes A, B, and C.

- A/V ratio ≥ 0.23
- Reverberation time $T_{\max} 0.7$ s (room acoustics class B)
- Noise level $L_{\text{NA,Beu}} < 40$ dB (room acoustics class B)

Lighting requirements

- Lighting standard EN 12646-1 minimum requirement
- Illuminance in the visual task area: 500 lx
- Uniformity: ≥ 0.6
- Good glare control: $\text{UGR} \leq 19$
- Luminance: < 3000 cd/m²

Specifications

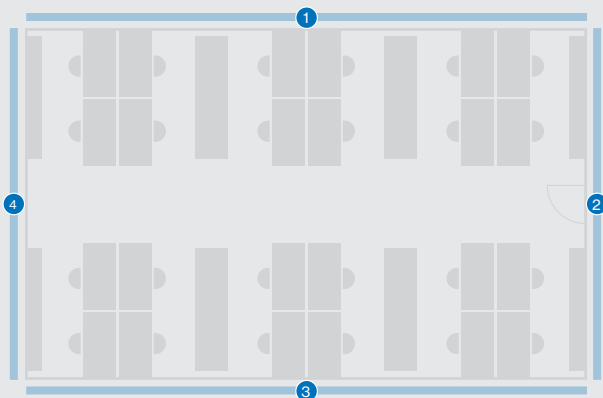

Room

24 employees
 6 working islands of four persons each
 Area: 112 m²
 Ceiling height: 3 m
 Volume: 336 m³

Equipment

- 1 Exterior wall with smooth plaster and window strip
- 2 Interior wall plasterboard with wooden door
- 3 Interior wall plasterboard
- 4 Exterior wall with smooth plaster

Ceiling: plasterboard
 Stone floor
 24 filing cabinets (triple height)
 24 tables, 24 office chairs

TASK



TASK
suspended

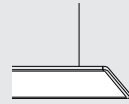

TASK square
acoustic module
suspended



TASK is our ultra-slim office luminaire series with the highest demands on lighting quality. The particularly flat TASK 1200 linear luminaire provides excellent glare-free, standard-compliant workplace lighting. An additional proportion of indirect light brightens up the ceiling, creating a pleasant visual environment while working at the screen. The TASK Acoustic Square acoustic elements can be arranged to form a highly effective grid above the centre of the room. Thus, traffic noise around the corridor is also effectively absorbed near the source.

Planned products:

- 12 × TASK 1200 suspended direct/indirect
- 18 × TASK acoustic square 1200 suspended

Lighting planning

- Illuminance in the field of vision: E_m 719 lx
- Uniformity in the field of vision: U_0 0.65
- Glare reduction (viewer): $UGR \leq 17$
- Lamp luminance: $< 3000 \text{ cd/m}^2$

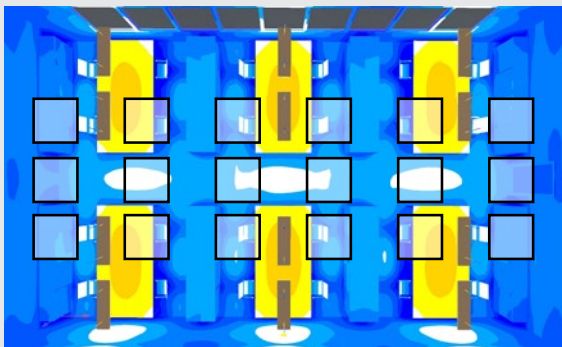

0.1 75 100 150 200 300 500 750 1000 1500 2000 3000 [lx]

Acoustics planning

- A/V ratio: ≥ 0.23
- Average reverberation time: 0.64 s
- Room acoustics class B

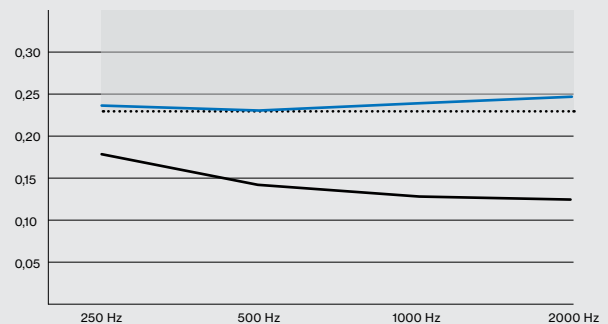

..... min. A/V ratio target area
— A/V ratio without acoustic elements — A/V ratio TASK

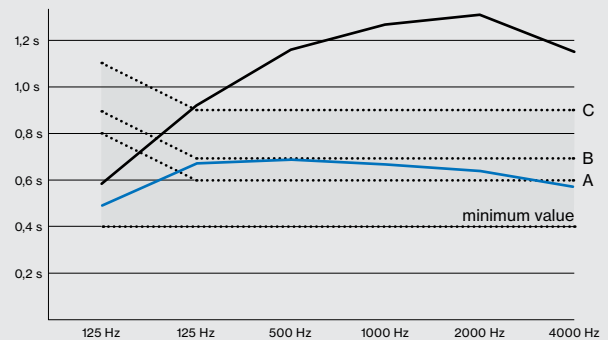

..... max. reverberation time class A, B, C target area
— reverberation time without acoustic elements — reverberation time TASK

TASK round



TASK 450 / 600
suspended

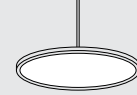

TASK round
acoustic module
suspended



TASK Round is a minimalist circular luminaire that can be freely positioned, thus allowing immense design diversity. Combined with likewise round, highly effective acoustic panels of various diameters, decorative structures and arrangements can be created. Custom colouring further extends the design scope. In addition to standard-compliant, well glare-reduced task lighting, TASK Round emits indirect light to the ceiling, creating a visually pleasant working environment.

Planned products:

- 16 × TASK round 1600 / 450 suspended direct/indirect
- 29 × TASK acoustic round 1200 / 900 / 600 suspended

Lighting planning

- Illuminance in the field of vision: E_m 601 lx
- Uniformity in the field of vision: U_0 0.68
- Glare reduction (viewer): $UGR \leq 18$
- Lamp luminance: $< 3000 \text{ cd/m}^2$

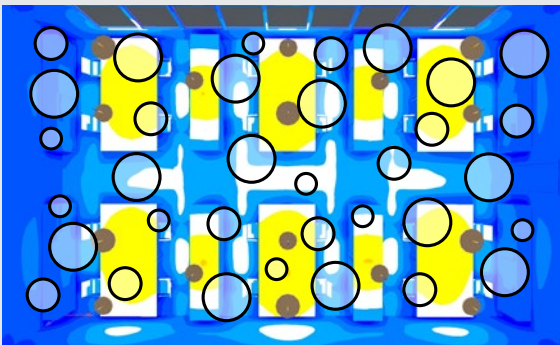

0.1 75 100 150 200 300 500 750 1000 1500 2000 3000 [lx]

Acoustics planning

- A/V ratio: ≥ 0.23
- Average reverberation time: 0.64 s
- Room acoustics class B

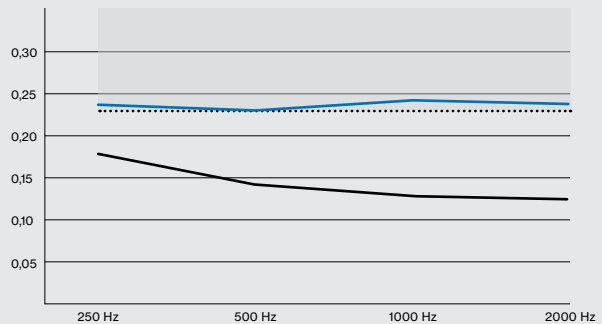

..... min. A/V ratio target area
— A/V ratio without acoustic elements — A/V ratio TASK

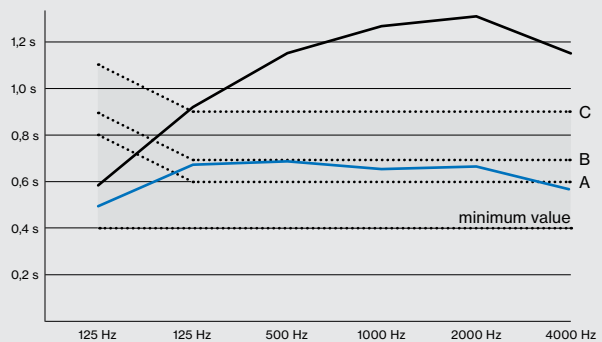

..... max. reverberation time class A, B, C target area
— reverberation time without acoustic elements — reverberation time TASK

MOVE IT 45



MOVE IT 45
suspended

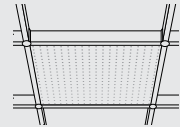

As a track system, MOVE IT 45 can be adapted to individual office situations as needed. Different lighting inserts can be combined as required in the 45mm narrow track: e.g., special lighting optics for use in offices that provide glare-free light and protects the eyes, with spotlights, wallwashers, or decorative luminaires. In this way, the impression of the room and the architectural design can be changed as desired. The square MOVE IT Acoustic 1200 acoustic elements can be inserted into the track system from behind – for easy-to-implement, visually appealing, and optimised room acoustics.

Planned products:

MOVE IT 45 tracks of various lengths (with indirect component) with 16 × L24 inset
14 × MOVE IT acoustic square

Lighting planning

- Illuminance in the field of vision: E_m 685 lx
- Uniformity in the field of vision: U_0 0.72
- Glare reduction (viewer): $UGR \leq 17$
- Lamp luminance: $< 3000 \text{ cd/m}^2$

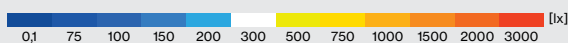
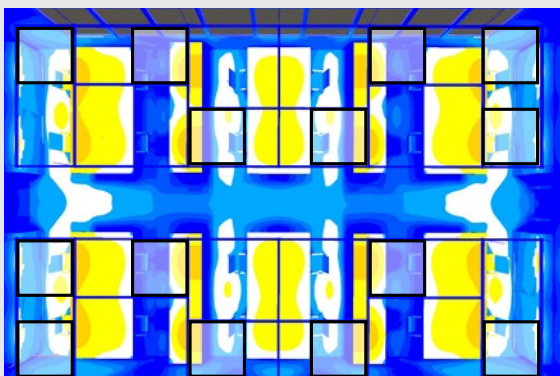

Acoustics planning

- A/V ratio: ≥ 0.23
- Average reverberation time: 0.65 s
- Room acoustics class B

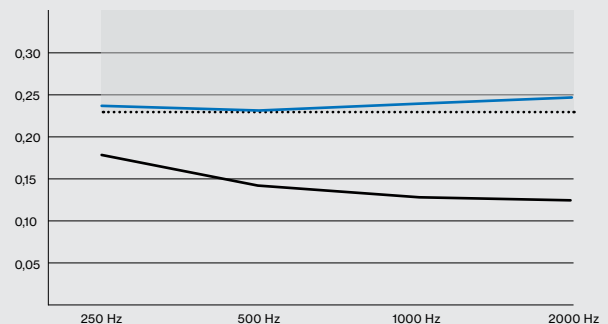

..... min. A/V ratio target area
— A/V ratio without acoustic elements — A/V ratio MOVE IT

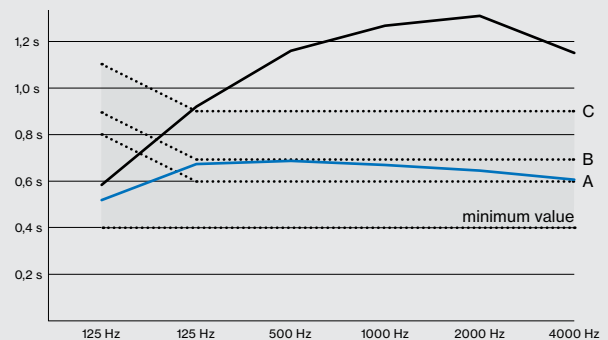

..... max. reverberation time class A, B, C target area
— reverberation time without acoustic elements — reverberation time MOVE IT

MUSE



MUSE single light
suspended

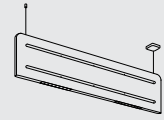

MUSE baffle
suspended

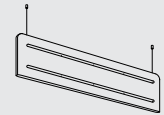

MUSE desk
high

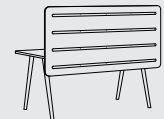

The MUSE product family is designed specifically for spaces where people communicate and work together. In addition to glare-free workplace lighting, MUSE ensures optimal acoustic furnishing of the office space through the perfect interplay of light and acoustics, combined in one product. Bespoke solutions, such as MUSE Light and MUSE Baffle, specifically reduce reverberation time and are therefore ideal for open-plan offices and shared spaces. Matching desk panels support privacy in multi-person offices by both creating visual separation and reducing sound propagation.

In large multi-person offices, sound propagation must be considered in addition to reverberation. The parameters for this are firstly the spatial decay rate of speech $D_{2,S}$ and secondly the sound pressure level of speech at a distance of 4m $L_{p,A,S,4m}$. Speech intelligibility (Speech Transmission Index) is an additional meaningful characteristic of pleasant room acoustics, which is why it is taken into account in our acoustic simulation. Since speech noise is a major distraction in multi-person offices, the STI should not exceed 0.5 over as large an area as possible.

Acoustic requirements

- A/V ratio: ≥ 0.22
- Reverberation time T_{max} 0.7s (room acoustics class B)
- Noise level $L_{NA,Bau} < 40$ dB (room acoustics class B)
- Spatial decay rate of speech ≥ 6 dB (level of sound propagation: 2)
- Sound pressure level of speech at a distance of 4m < 49 dB (level of sound propagation: 2)
- Speech Transmission Index STI: if possible ≤ 0.5

Lighting requirements

- Lighting standard EN 12646-1 minimum requirement
- Illuminance in the visual task area: 500 lx
- Uniformity ≥ 0.6
- Glare limitation $UGR \leq 19$
- Luminance: < 3000 cd/m²

Planned products:

- 44 × MUSE light
- 24 × MUSE baffle
- 16 × MUSE desk high

Specifications

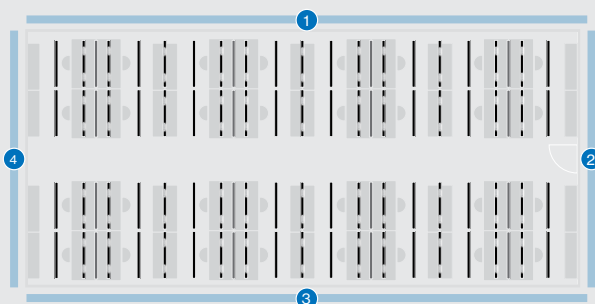

Room

32 employees
8 working islands of 4 persons each
Area: 150 m²
Ceiling height: 3.20 m
Volume: 478 m³

Ceiling: plasterboard
Stone floor
32 filing cabinets (triple height)
32 tables, 32 office chairs

Equipment

- 1 Exterior wall with smooth plaster and window strip
- 2 Interior wall plasterboard with wooden door
- 3 Interior wall plasterboard
- 4 Exterior wall with smooth plaster

Lighting planning

- Illuminance in visual range E_m 536 lx
- Uniformity in the field of vision: U_0 0.65
- Glare reduction (viewer): $UGR \leq 19$
- Lamp luminance: $< 3000 \text{ cd/m}^2$

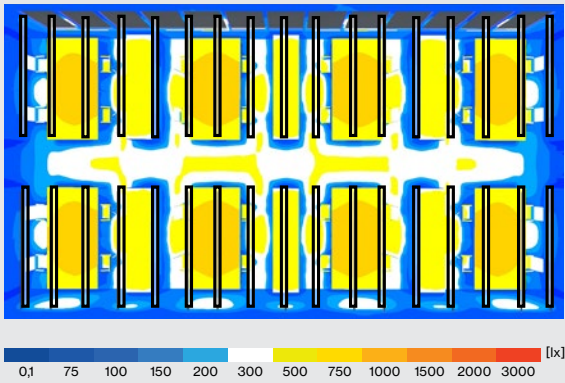

Acoustics planning – Reverberation

- A/V ratio $\geq 0,22$
- Average reverberation time 0.62 s
- Room acoustics class B

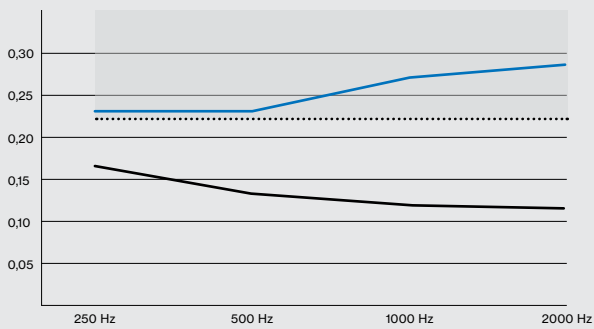

..... min. A/V ratio target area
 — A/V ratio without acoustic elements — A/V ratio MUSE

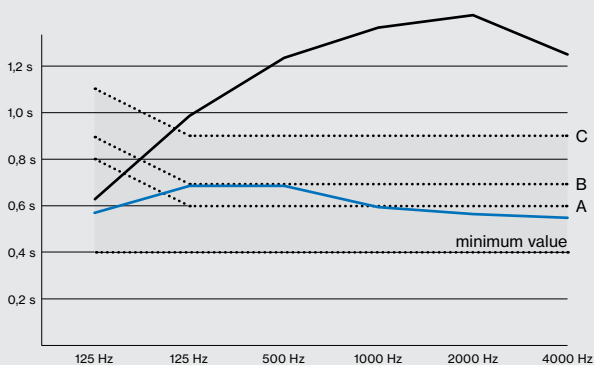

..... max. reverberation time class A, B, C target area
 — reverberation time without acoustic elements — reverberation time MUSE

Acoustics planning – Sound propagation

- Spatial decay rate $D_{2,S} \geq 6.2 \text{ dB}$
- Sound pressure level of speech at a distance of 4 m
 $L_{p,A,S,4m} < 48.8 \text{ dB}$
- Sound propagation level: 2

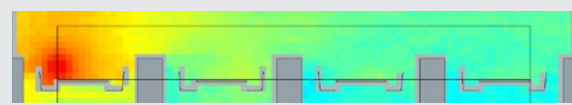
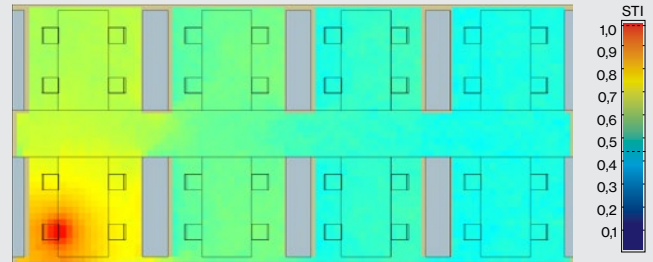

Speech Transmission Index: without acoustic elements

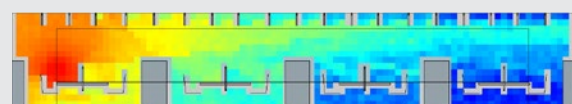
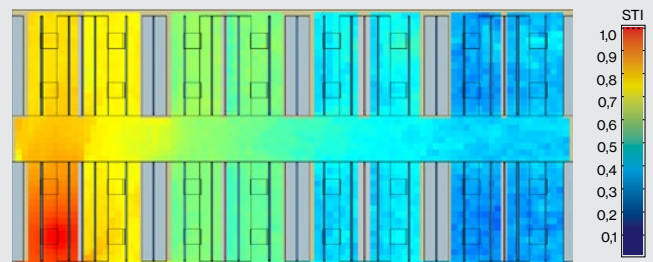

Speech Transmission Index: XAL MUSE

Personal note

We support you with bespoke and standard-compliant acoustic planning.

For this purpose, we work with different methods; from simple calculations to 3D simulations with realistic sound wave propagation to exact on-site sound measurements.

We create a holistic lighting and acoustic concept in close coordination with you and our lighting design team. This allows us to strike the best balance between lighting, ambience, and room-acoustic conditions. If you have any questions or would like to arrange an individual consultation for your project, please contact us at acoustics.planning@xal.com

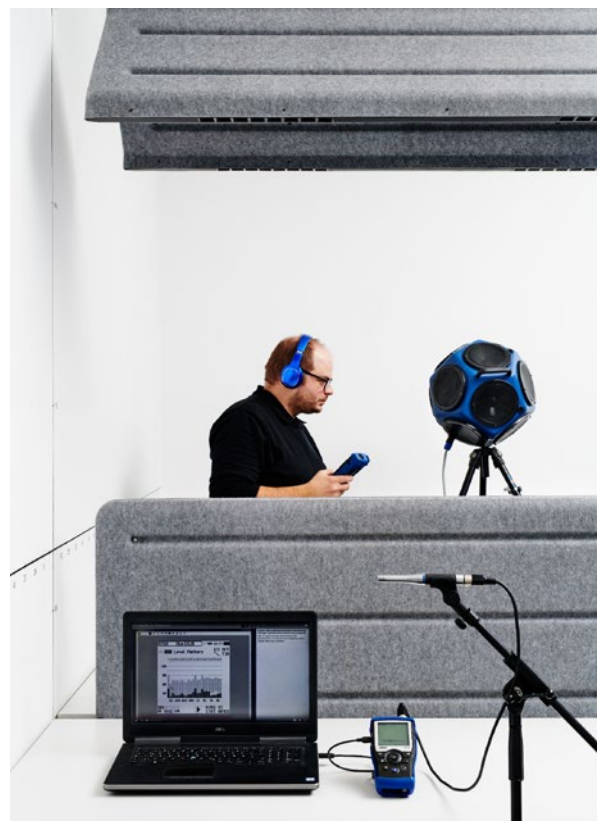

XAL Headquarters

XAL GmbH
Auer-Welsbach-Gasse 36
8055 Graz
AUSTRIA
T +43.316.3170
office@xal.com

All locations:
xal.com/contacts

List of photographers

Felix Löchner Architekturfotografie (p. 2), Ditz Fejer (p. 8 | 48), Michael Königshofer (p. 8-9 | 78), Lilly Mörz (p. 8 | 26), Schneider & Schütz GmbH (p. 16-17 | 42), Nick Rezendes Photography (p. 18-19), peal GmbH (p. 20 | 44), Andrew Albert (p. 21), Corinna Klug (p. 21), Catherine Roeder Fotografie (p. 22), Alexander Schwarz (p. 27), PION Studio (p. 30-31), Kris Dekeijser (p. 32), Richard Kiely (p. 33), Kurt Kuball (p. 34), Tõnu Tunnel (p. 36-39), OZ, Valentijn Kortekaas (p. 40), Erich Sinzinger (p. 43), Andreas Keller Fotografie (p. 45), Hagen Stier (p. 46), Uzi Porat (p. 50), Vesa Loikas Photography (p. 51)

Legal notices

The information in this catalogue corresponds to the status at the time of printing, is non-binding and is intended for information purposes only. No liability is assumed for deviations of a product from illustrations or specifications. We reserve the right to make changes to our products at any time. All orders are accepted exclusively based on our General Terms and Conditions of Business and Delivery, which can be viewed at www.xal.com, in the current version.

